

LOW PROFILE SCORPION

Slim Modular Power & Signal Contact Connectors



- Four power contact options: 55 amps, 38 amps, 12 amps and 3 amps versions plus high density signal lines.
- Blind mating, float mount, panel mount and cable connector options with unique locking system.
- Ventilation option to offer increased air cooling.



POSITRONIC®
GLOBAL *Connector* SOLUTIONS

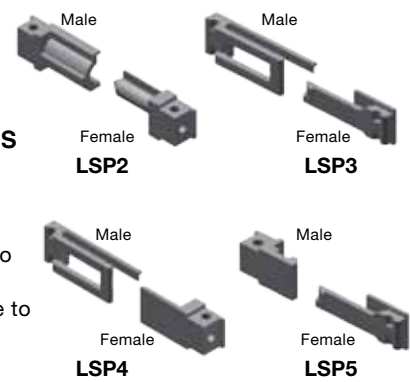
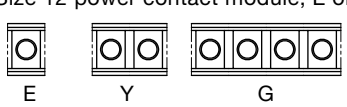
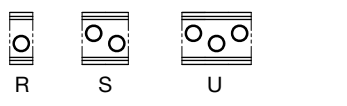
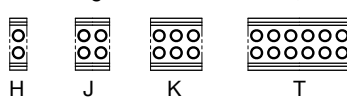
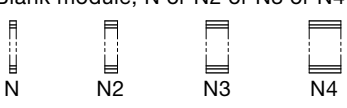
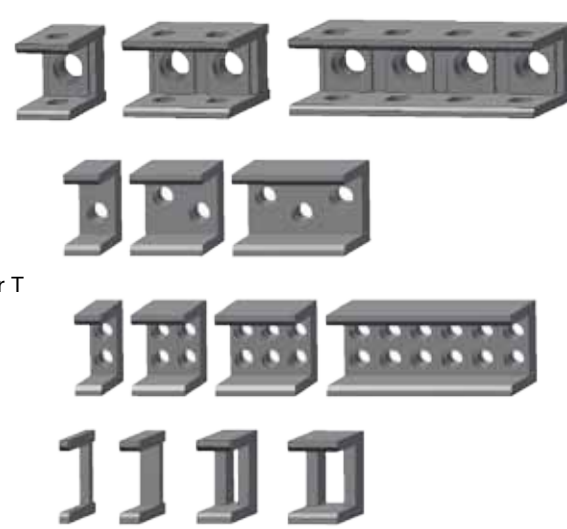

Ordering Information - Code Numbering System

Specify complete connector by selecting an option from step 1 through 9
(Consult sales for connectors' length exceeding 101mm or part numbers using more than 30 characters)

STEP	1	2	3	4	5
Example	LSP	2	YKNRS	4	M
STEP 1: BASIC SERIES LSP : Low Profile Scorpion Series.					
STEP 2: GUIDE AND LOCKING OPTIONS 2 : Blind Mating System. 3 : Locking Latch System, for cable to cable connectors only. 4 : Locking Latch System, for male cable to female panel/board connectors only. 5 : Locking Latch System, for female cable to male panel/board connectors only.					
STEP 3: CONNECTOR VARIANTS Size 12 power contact module, E or Y or G  Size 20 power contact module, R or S or U  Size 22 signal contact module, H or J or K or T  Blank module, N or N2 or N3 or N4  Consult sales for availability of other modules. It is recommended signal contacts are positioned at the center of connector.					
STEP 4: CONTACT TERMINATION TYPE 1 : Crimp contacts, order separately. 3 : Solder, straight PCB mount. 38 : Solder, straight PCB mount. High conductivity power contacts. 4 : Solder, right angle (90°) PCB mount. 48 : Solder, right angle (90°) PCB mount. High conductivity power contacts. *93 : Press-fit compliant terminations, straight PCB mount, for use with PCB not thinner than 2.29[0.090]. *938 : Press-fit compliant terminations, straight PCB mount, for use with PCB not thinner than 2.29[0.090]. High conductivity power contacts. * Consult sales for availability of press-fit compliant terminations or mixed contact termination type.					
STEP 5: CONNECTOR GENDER M : Male F : Female - Standard contacts. S : Female - Posiband contacts					

Notes:

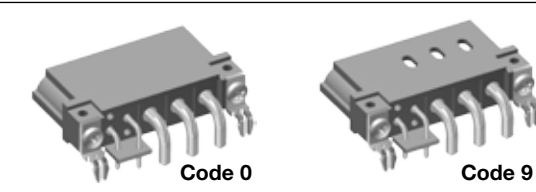
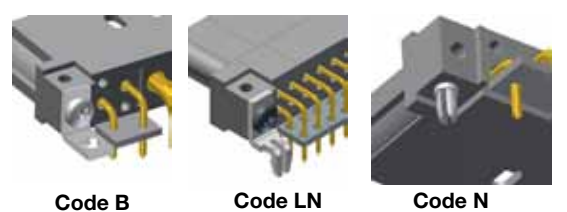
- 1 A Low Profile Scorpion part number can be a maximum of 30 characters. If the connector configuration exceeds this number, please consult sales for a special part number for your unique requirement.
- 2 Consult sales for connector length exceeding 101.00 mm [3.976 inch].
- 3 Alignment bar is only available for size 20 and size 22 right angle (90°) contacts.

6	7	8	9	10	11
0	N	9	A1	/AA	XXX
					STEP 11: SPECIAL OPTIONS Consult sales for Special Options
					STEP 10: ENVIRONMENTAL COMPLIANCE OPTIONS /AA : Compliant per EU Directive 2002/95/EC (RoHS) Example: LSP5YN2HK4M000A1/AA Note: This step will not be used if compliance to environmental legislation is not required. Example: LSP5YN2HK4M000A1
					STEP 9: CONTACT PLATING 1 : Crimp contacts ordered separately. A1 : Gold flash over nickel on mating end termination end. A2 : Gold flash over nickel on mating end and 0.005[0.0002] tin-lead solder coat on termination end. Not available with code 93, 938 in step 4. C1 : 0.00076[0.000030] gold over nickel on mating end and termination end. C2 : 0.00076[0.000030] gold over nickel on mating end and 0.005[0.0002] tin-lead solder coat on termination end. Not available with code 93, 938 in step 4. D1 : 0.00127[0.000050] gold over nickel on mating end and termination end. D2 : 0.00127[0.000050] gold over nickel on mating end and 0.005[0.0002] tin-lead solder coat on termination end. Not available with code 93, 938 in step 4. Consult sales for availability of silver plating.
					STEP 8: VENT OPTIONS (For power contacts) 0 : Connector body is not vented. 9 : Connector body vented for air cooling. 
					STEP 7: MOUNTING STYLE 0 : Not applicable / No additional accessories. B : 90° metal mounting bracket (through hole), for right angle PCB mounted connectors use code 4 or 48, see step 4. LN : 90° metal mounting bracket (board lock), for right angle PCB mounted connectors use code 4 or 48, see step 4. N : Push-on fastener for PCB mounted connectors use code 3, 38, 4 or 48, see step 4. 
					STEP 6: PANEL MOUNT 0 : Not applicable / No added accessories. 6 : Easy release mounting clip for 1.50mm [0.059 inch] thick panel, for male panel mount connector only. 82 : Float mount for 1.50 mm [0.059 inch] thick panel. 83 : Float mount for 2.30 mm [0.091 inch] thick panel. 



Materials and Finishes:

- Insulators:** Glass-filled polyester, UL 94V-0. Black color (Blue optional).
- Contacts:** Precision machined copper alloy with gold flash over nickel plate. Other finishes available upon request.
- Mounting Brackets:** Brass with tin plate.
- Push-on Fasteners:** Copper alloy with tin plate.
- Float Mount Bushings:** Steel with zinc plate.

Electrical Characteristics:

Contact Current Rating (See Page 5 for Power Contact Details)

Standard Conductivity Contacts:

- Size 12 Contacts:** 38 amperes, continuous.
- Size 20 Contacts:** 12 amperes, continuous.
- Size 22 Contacts:** 3 amperes, nominal.

High Conductivity Contacts:

- Size 12 Contacts:** 55 amperes, continuous.

Initial Contact Resistance (Standard Conductivity Contacts) per IEC 512-2, Test 2b:

- Size 12 Contacts:** 0.001 ohms, maximum.
- Size 20 Contacts:** 0.005 ohms, maximum.
- Size 22 Contacts:** 0.005 ohms, maximum.

Initial Contact Resistance (High Conductivity Contacts) per IEC 512-2, Test 2b:

- Size 12 Contacts:** 0.0007 ohms, maximum.

Insulation Resistance per IEC 512-2, Test 3a, Method A: 5 G ohms.

Voltage Proof per IEC 512-2, Test 4a, Method C:

- Size 12 and size 20 contacts, 2200 V r.m.s.
- Size 22 contacts, 1800 V r.m.s

Working Voltage, Clearance and Creepage Distances:

Consult sales for information about your specific connector choice.

Hot Pluggable [50 Couplings per UL 1977, paragraph 15]:

- Size 12 Contacts:** Contact sales for availability.

Climatic Characteristic:

- Working Temperature:** -55°C to +125°C.

Mechanical Characteristics:

- Blind Mating System:** Integral guide feature allows for misalignment up to 2.00 mm [0.079 inch].

- Locking Latch System:** Design of connector body provides locking system for cable to cable, cable to printed board and cable to panel mount applications.

- Polarization:** Design of connector body provides polarization features.

- Removable Crimp Contacts:** Size 12, 20 and 22 female contacts feature closed entry design for highest reliability. Install contacts from rear of insulator. To remove contacts, release from front of insulator with extraction tool and remove from rear of insulator.

Removable Contact Retention in Connector Body per IEC 512-8, Test 15a:

- Size 12 Contacts:** 67N [15 lbs.] minimum.
- Size 20 and Size 22 Contacts:** 27N [6 lbs.] minimum.

Non Removable Crimp Contacts

- (Size 22 only):** Size 22 female contacts feature closed entry design for highest reliability. Insert contact from rear of insulator.

Non Removable Crimp Contact Retention in Connector Body per IEC 512-8, Test 15a:

- Size 22 Contacts:** 27N [6 lbs.] minimum.

- Fixed Contacts:** Printed board terminations, both straight and right angle. Size 12 female contacts feature closed entry design for highest reliability. Size 20 and 22 female contact has open entry design.

Fixed Contact Retention in Connector Body per IEC 512-8, Test 15a:

- Size 12 Contacts:** 45N [10 lbs.] minimum.
- Size 20 Contacts:** 45N [10 lbs.] minimum.
- Size 22 Contacts:** 27N [6 lbs.] minimum.

Sequential Contact Mating System:

- Size 12 Contacts:** Two levels.
- Size 20 Contacts:** One level. (Two levels for Printed Board mount connectors.)
- Size 22 Contacts:** One level. (Two levels for Printed Board mount connectors.)

Printed Board and Panel Mounting Holes:

Mounting holes provided in connector body for both printed board and panel mounting. Self-tapping screws or push-on fastener options are available.

Mechanical Operations

- per IEC 512-5:** 1000 cycles minimum.

Recognized:

- UL and TÜV:** Consult sales.

Products described within this catalog may be protected by one or more of the following U.S. patents:
 #4,721,472
 #4,900,261
 #5,255,580
 #5,329,697
 #6,260,268
 Patented in Canada, 1992. Other Patents Pending.

Unless otherwise specified, dimensional tolerances are:

- 1) Male contact mating diameters : ±0.03 [0.001]
- 2) Contact termination diameters : ±0.08 [0.003]
- 3) All other diameters : ±0.13 [0.005]
- 4) All other dimensions : ±0.38 [0.015]

Dimensions are in millimeters [inches]. All dimensions are subject to change.

Information in this catalog is proprietary to Positronic and its subsidiaries. Positronic believes the data contained herein to be reliable. Since the technical information is given free of charge, the user employs such information at his own discretion and risk. Positronic Industries assumes no responsibility for results obtained or damages incurred from use of such information in whole or in part.

Positronic®, Positronic Industries, Inc.®, P+ logo, Positronic Global Connector Solutions®, Connector Excellence® and their logo designs are registered trademarks of Positronic Industries, Inc. PICMG® logo is a registered trademark of the PCI Industrial Computers Manufacturers Group.



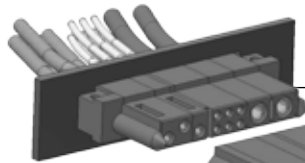

Board to Panel with Blind Mating System

Female Panel Mount Connector

Typical part number:
LSP2YKNRS1F0001
(Contacts ordered separately)

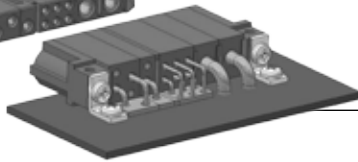

Male Right Angle PCB Mount Connector

Typical part number:
LSP2YKNRS4M0B0A1

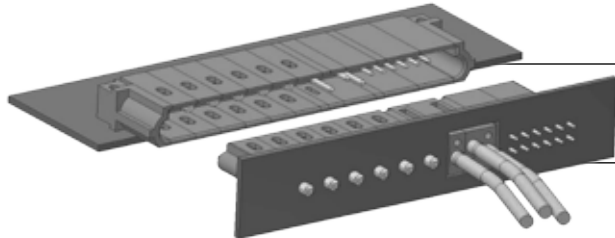

Board to Board with Crimp Contacts Pass-through

Male Right Angle (90°) PCB Connector

Typical part number:
LSP2YGN2UN2T4M009A1



Female Straight PCB Connector

Typical part number:
LSP2YGN2UN2T3F009A1-PAxxx
(Crimp contacts ordered separately)

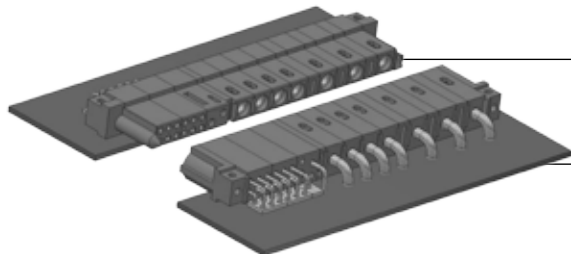

Board to Board with Blind Mating System

Female Right Angle(90°) PCB Connector

Typical part number:
LSP2EN3EN3EN3GN2ST4F009A1

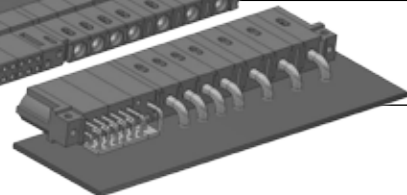

Male Right Angle(90°) PCB Connector,

Typical part number:
LSP2EN3EN3EN3GN2ST4M009A1

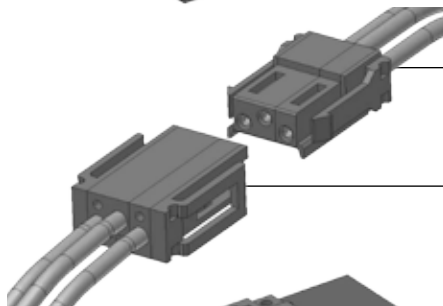

Cable to Cable with Locking Latch System

Female Cable Connector

Typical part number: LSP3U1F0001
(Contacts ordered separately)

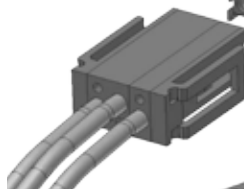

Male Cable Connector

Typical part number: LSP3U1M0001
(Contacts ordered separately)

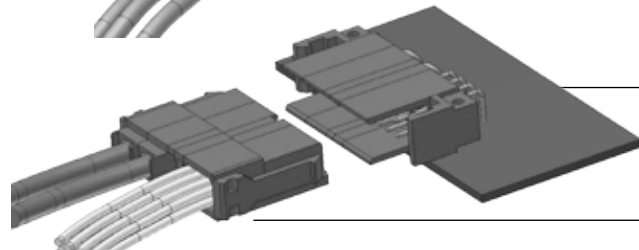

Cable to Board with Locking Latch System

Male Right Angle PCB Mount Connector

Typical part number: LSP5YN2HK4M000A1

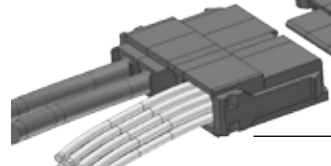

Female Cable Connector

Typical part number: LSP5YN2HK1F0001
(Contacts ordered separately)

How to calculate Over All Length (OAL) of a Low Profile Scorpion connector:

Overall Length (OAL) of a connector is the sum of all the modules length. Refer to example below for OAL calculation. See page 5 and 7 for individual module dimensions.

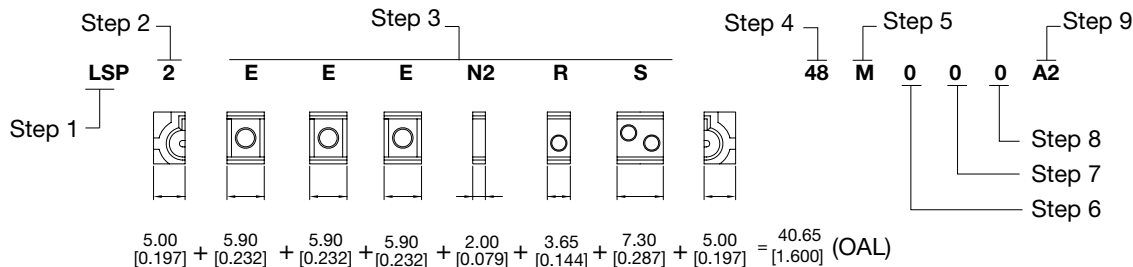



Temperature Rise Curves

Tested per IEC Publication 512-3, Test 5a

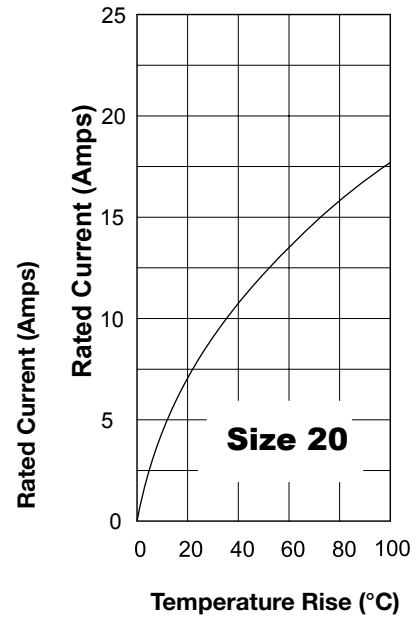
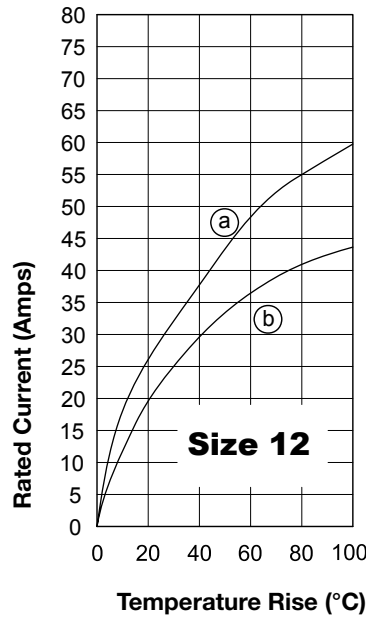
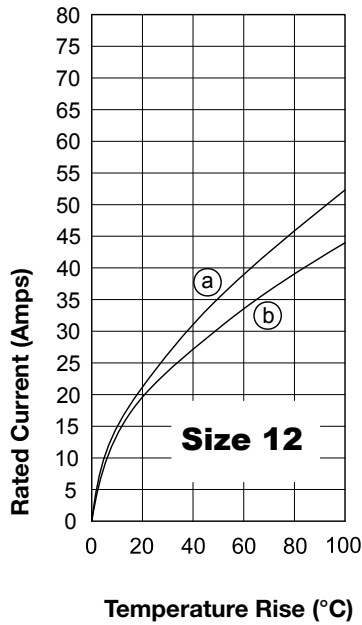

(a) Developed with 3 size 12 high conductivity contact seated in code EEE module.

(b) Developed with 3 size 12 standard conductivity contact seated in code EEE module.

(a) Developed with 7 size 12 high conductivity contacts seated in code EN3EN3EN3EEEE module.

(b) Developed with 7 size 12 standard conductivity contacts seated in code EN3EN3EN3EEEE module.

Developed with 2 size 20 standard conductivity contacts seated in code S module.

Contact sales if additional testings and current ratings are required.

Guide Systems and Locking Options

See Step 2 of Ordering Information

Blind Mating Guide System

Specify Code 2 in Step 2

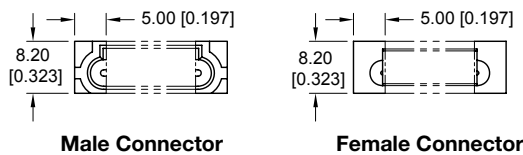

Cable to Cable Locking Latch System

Specify Code 3 in Step 2

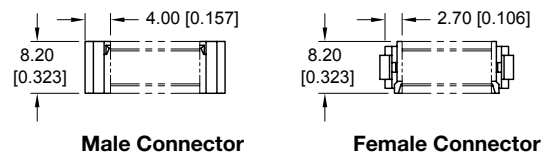

Male Cable to Female Panel/Board Locking Latch System

Specify Code 4 in Step 2

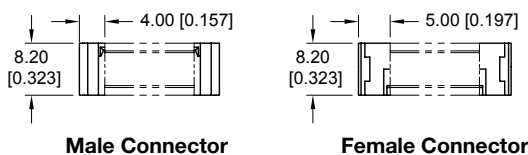

Female Cable to Male Panel/Board Locking Latch System

Specify Code 5 in Step 2

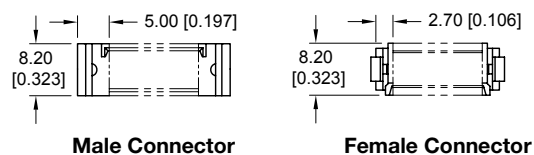



Insulator Dimensions when using Blind Mating System

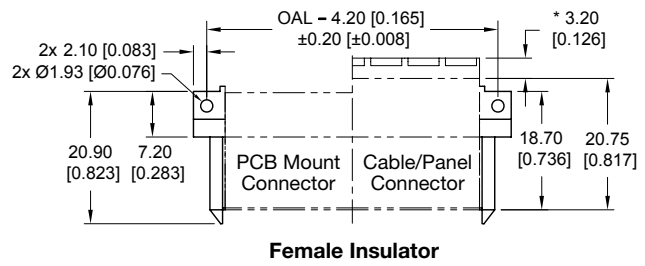
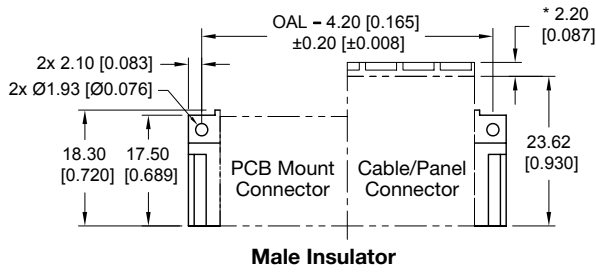

* Dimension applicable for Size 12 power contact module only.

Insulator Dimensions when using Locking Latch System

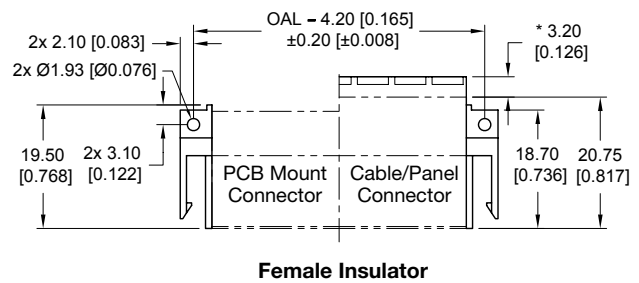
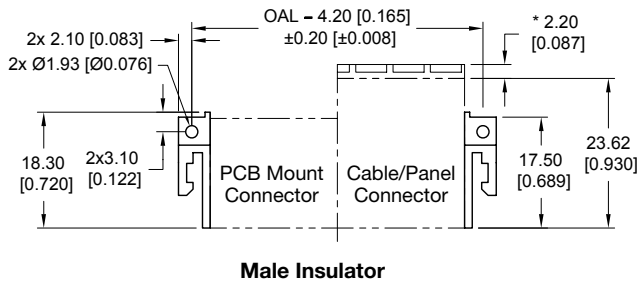
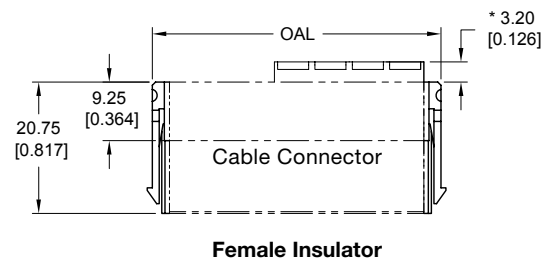
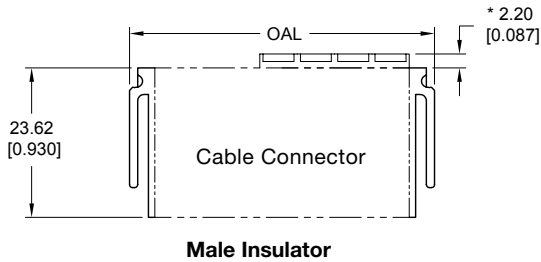

* Dimension applicable for Size 12 power contact module only.

Venting Features

Specify Code 9 in Step 8 of Ordering Information

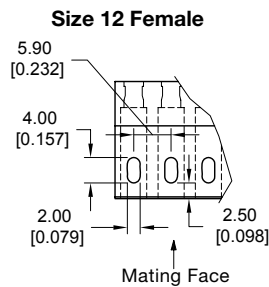
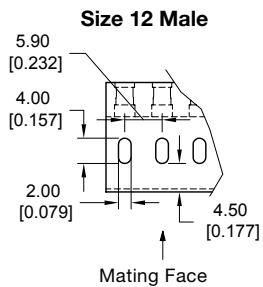

Venting feature is an outlet hole enabling air cooling onto a power contact.

In compliance with UL 1977 safety standard, section 10.2 Accessibility of live parts.





Module Options

See Step 3 of Ordering information

Size 12 Power Contact Modules

Module E

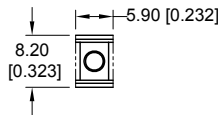

Module Y

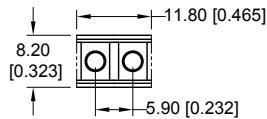

Module G

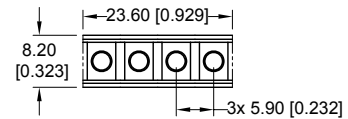

Size 20 Power / Signal Contact Modules

Module R

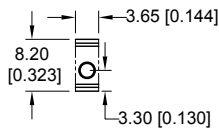

Module S

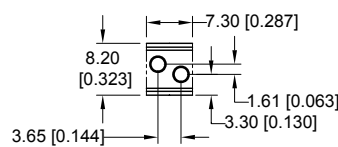

Module U

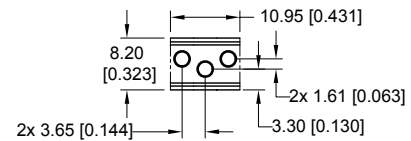

Size 22 Signal Contact Modules

Module H

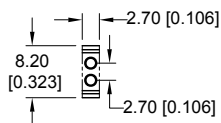

Module J

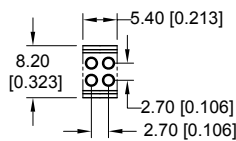

Module K

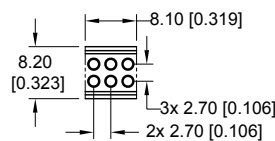

Module T

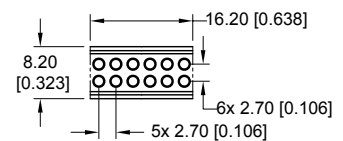

Blank Modules

Module N

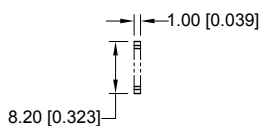

Module N2

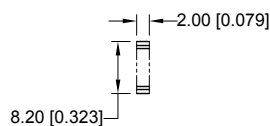

Module N3

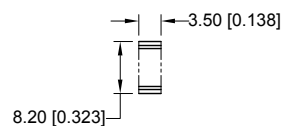

Module N4

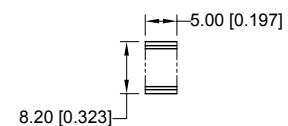

All modules shown above are male modules.

Available in female straight and right angle (90°) PCB mount. Consult sales for availability of other modules.

Contact Termination Dimensions

See Step 4 of Ordering information

Straight PCB Mount Connectors

Specify Code 3 or 38 in Step 4

Size 12 contacts

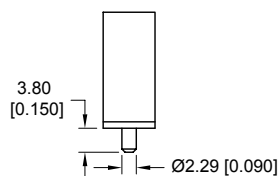

Size 20 contacts

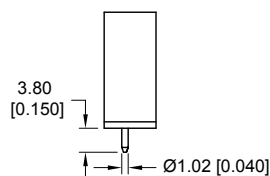

Size 22 contacts

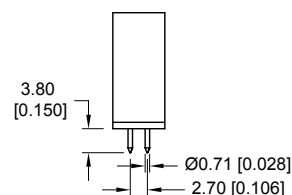

Code 3 is standard conductive material contact and code 38 is high conductivity material power contact.





Right Angle (90°) PCB Mount Connectors

Specify Code 4 or 48 in Step 4

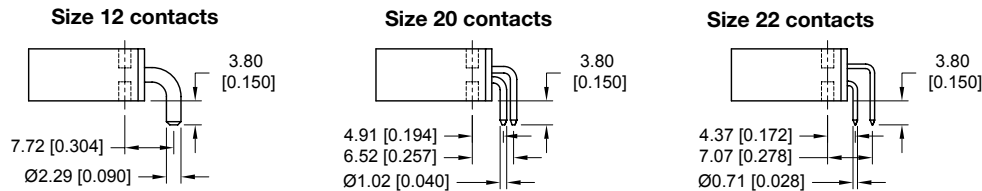

Code 4 is standard conductive material contact and code 48 is high conductivity material power contact.

Press-Fit Straight PCB Mount Connectors

Specify Code 93 or 938 in Step 4

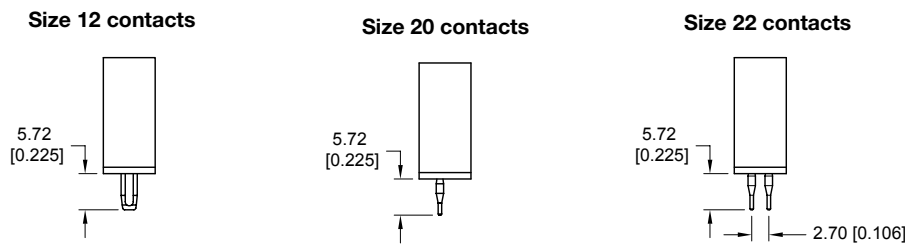

Code 93 is standard conductive material contact and code 938 is high conductivity material power contact.

Male connector shown for reference. Dimensions also apply to female connector.

Note: Outline dimensions for Press-Fit Connectors are the same as those of Straight PCB Mount Versions. For Suggested Straight Mount PCB Holes Sizes of Compliant Press-Fit Connectors, please refer to SK6370 or consult sales for more informations.

Press-Fit User Information

Connectors-to-PCB installation instructions:

1. Insert the connector into the PCB or backplane and seat connector fully with seating/ support tool.
2. Secure the connector to the PCB or backplane using two self-tapping screws for plastic.
3. Consult factory for appropriate installation tools.

Mounting Screw

Material Options	Part Number	Thread Length	P.C.B Thickness
Steel	4546-7-1-16	6.35±0.76 [0.250±0.030]	2.36 [0.093]
Steel	4546-7-2-16	7.93±0.76 [0.312±0.030]	3.18 [0.125]
Steel	4546-7-3-16	9.53±0.76 [0.375±0.030]	4.45 [0.175]
Stainless Steel	4546-7-6-4	6.35±0.76 [0.250±0.030]	2.36 [0.093]
Stainless Steel	4546-7-7-4	7.93±0.76 [0.312±0.030]	3.18 [0.125]
Stainless Steel	4546-7-8-4	9.53±0.76 [0.375±0.030]	4.45 [0.175]





Accessories for PCB Mount

See Step 7 of Ordering Information

90° Through Hole Brackets

Specify code B in Step 7

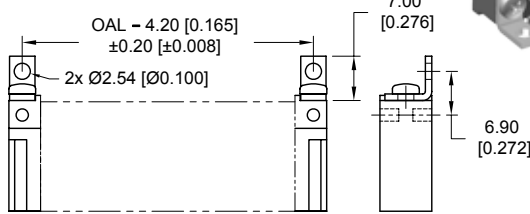

Material and Finish: Brass with tin plate.

90° Board Lock Brackets

Specify code LN in Step 7

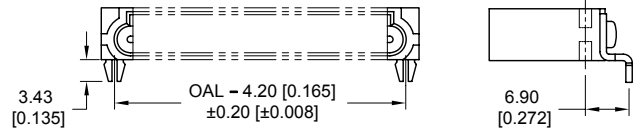

Material and Finish: Brass with tin plate.

Push-on Fasteners

Specify code N in Step 7

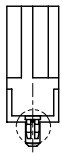

Straight PCB Mount Connector

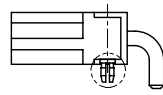

Right Angle (90°) PCB Mount Connector

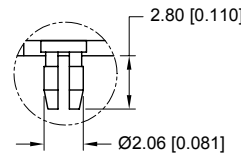

Material and Finish:
Copper alloy with tin plate.

Male connector shown for reference only. Consult sales for mounting screw information.

Accessories for Panel Mount

See Step 6 of Ordering Information

Easy Release Mounting Clips

Specify code 6 in Step 6

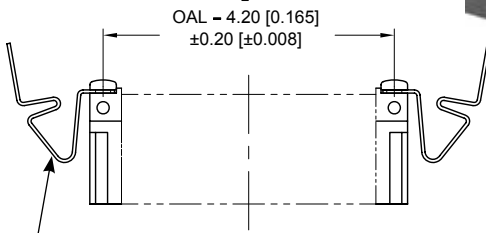

Material and Finish:
Beryllium copper with nickel plate.
For male connector only.

Float Mount Bushings

Specify Code 82 or 83 in Step 6

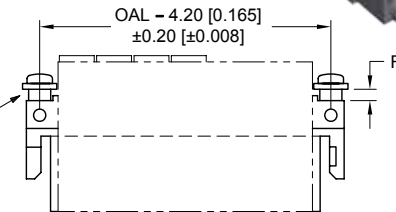

Material and Finish:
Steel with zinc plate.

Code	Panel Thickness	Dimension F
82	1.50 [0.059]	1.80 [0.071]
83	2.30 [0.091]	2.60 [0.102]

Panel Cutout Dimensions

For Mounting Screws

Specify code 0 in Step 6

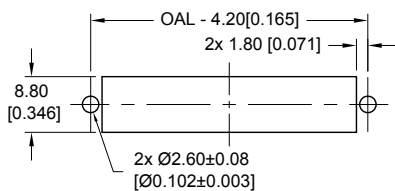

For Float Mounting

Specify code 82 or 83 in Step 6

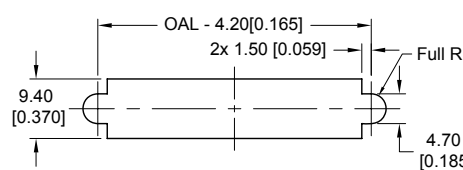

For Quick Release Mounting Clip

Specify code 6 in Step 6

(Maximum panel thickness: 1.60 [0.063] nominal)

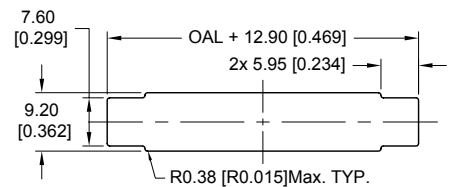

General tolerance for panel cutout dimensions is ± 0.13 [± 0.005].

To calculate OAL of connector. See example at bottom of page 4 **Typical LSP Modular Connectors**





Size 12 Removable Crimp Contacts

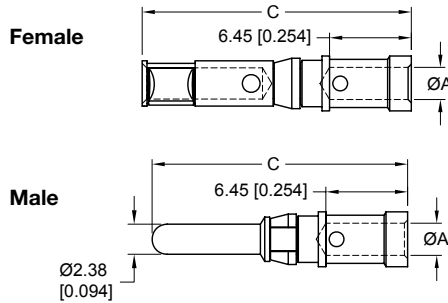

Part Number (Standard Conductivity Contacts)	Part Number (High Conductivity Contacts)	Wire Size AWG [mm ²]	ØA	Sequential Mate	C
Female Contacts					
FC1210P2	FC1210P2S	10 [6.0]	3.10 [0.122]	N/A	21.25 [0.837]
FC1212P2	FC1212P2S	12 [4.0]	2.54 [0.100]		
Male Contacts					
MC1210N-PA563	MC1210NS-PA563	10 [6.0]	3.10 [0.122]	First	23.18 [0.912]
MC1210N	MC1210NS			Standard	20.18 [0.794]
MC1212N-PA563	MC1212NS-PA563	12 [4.0]	2.54 [0.100]	First	23.18 [0.912]
MC1212N	MC1212NS			Standard	20.18 [0.794]

N/A - Not Applicable

Size 20 Removable Crimp Contacts

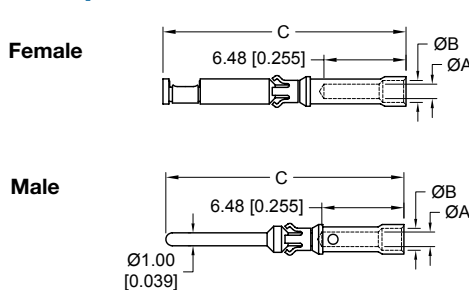

Part Number (Standard Conductivity Contacts)	Wire Size AWG [mm ²]	ØA	ØB	Sequential Mate	C
Female Contacts					
FC718P3	18 [1.0]	1.40 [0.055]	N/A	N/A	19.19 [0.756]
FC720P3	20-22-24 [0.5-0.3-0.25]	1.14 [0.045]	1.73 [0.068]		
Male Contacts					
MC718N	18 [1.0]	1.40 [0.055]	N/A	Standard	18.80 [0.740]
MC720N	20-22-24 [0.5-0.3-0.25]	1.14 [0.045]	1.73 [0.068]		

N/A - Not Applicable

Size 22 Non Removable Crimp Contacts

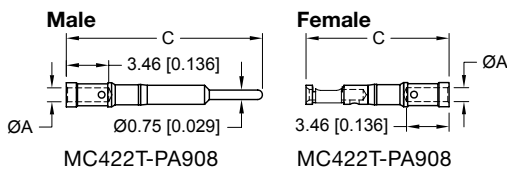

Removable Contact	Non Removable Contact	Wire Size AWG [mm ²]	ØA	C
Female Contacts				
FC422P9	FC422T-PA908	22 - 26 [0.30] - [0.12]	0.89 [0.035]	11.41 [0.449]
Male Contacts				
MC422N9	MC422T-PA908	22 - 26 [0.30] - [0.12]	0.89 [0.035]	15.49 [0.610]

Size 22 Removable Crimp Contacts

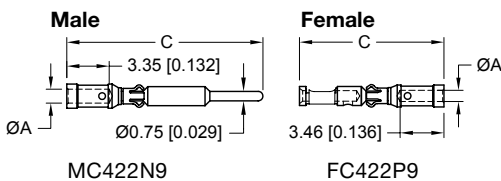

Materials and Finishes:

Precision machined copper alloy with gold flash over nickel.

Consult sales for other contact sizes, materials, finishes, termination styles and more details.





Recommended Tools for Crimp Contacts

Contact Extraction Tool

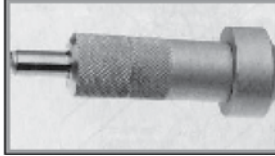

Contact Insertion Tool

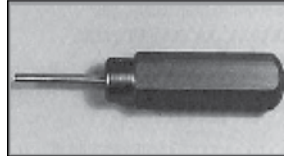

Cycle-Controlled Step Adjustable Hand Crimp Tool



Contact Size	Contact Extraction Tool	Contact Insertion Tool	Hand Crimp Tool
Size 12	2711-0-0	9099-3-0	9509-6-1 with 9509-6-2 positioner (*C1210** contacts) 9501-0 with 9502-38-0 positioner (MC1212** contacts) 9501-0 with 9502-37-0 positioner (FC1212** contacts)
Size 20	9081-2-0	9099-4-0	9507-0 with 9502-21 positioner (male contacts) 9507-0 with 9502-22 positioner (female contacts)
Size 22	^ 9081-3-0	9099-7-0	9507-0 with 9502-12-0 positioner (male contacts) 9507-0 with 9502-13-0 positioner (female contacts)





^ Not Applicable for Size 22 non-removable crimp contacts.
Consult sales for additional crimping tools and crimping information.

SCORPION MODULAR CONNECTORS
Complete Connector Customization - Quick and Affordable

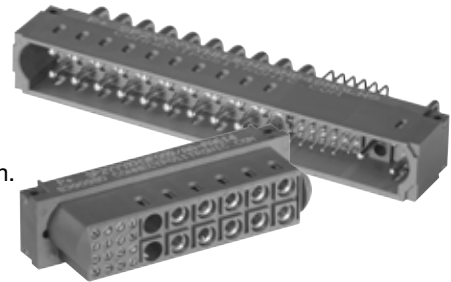

- Six power contact options: 20 amp versions through 85 amp.
- High density signal lines.
- Shielded contacts and high voltage options.
- Blind mating, float mount, panel mount and cable connector options with unique locking system.
- PC mount, crimp, and press fit terminations.
- Ventilation option to increase air cooling.
- Blank modules to increase voltage performance.



Blind Mating Guide Systems	50 Amp Power Contacts Modules	Blank Modules for Voltage Considerations	High Density Signal Contact Modules	Unique Locking Systems
				
14.60	30 Amp Power Contacts Modules	Size 22 Signal Contact Modules	85 Amp Power Contacts Modules	Size 18 20 Amp Contacts
				Jackscrew Option

Please refer to Scorpion Series Catalog No. A-010. Rev B for additional informations



High Density Rectangular Connectors

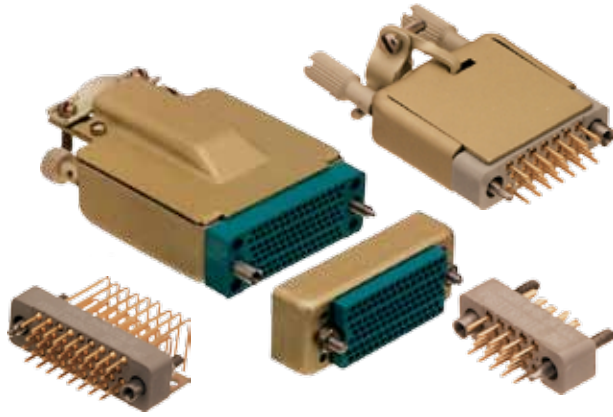

SGM/SGMC/SMPL Series

CRIMP & SOLDER TERMINATIONS FOURTEEN CONTACT VARIANTS 4 through 104 poles

CONTACTS: Fixed and removable. Precision machined of solid copper alloy. Female contact is "closed entry" design for highest reliability. Current rating to 5 amperes continuous per contact. Gold flash over nickel plate. Other finishes available upon request. **TERMINATIONS:** Crimp; solder cup; straight and right angle solder printed board mount.

INSULATORS: Glass-filled DAP, U.L. 94V-0. Variants of 4, 5, 7, 9, 11, 14, 20, 26, 29, 34, 44, 50, 75 and 104 contacts. **POLARIZATION:** Guide pilots and sockets, jackscrews and shells. **LOCKING SYSTEM:** Jackscrews and vibration lock system. **CABLE ADAPTERS:** Hoods, aluminum. **MOUNTING:** Panel and printed board. **WORKING TEMPERATURE:** -55°C to +125°C. **CRIMPING TOOLS:** Automatic and manual. **MILITARY QUALIFICATIONS:** Conform to MIL-DTL-28748/7, /8, /13, and /14 and SAE AS 39029/34 and /35. IEC 807-7, performance level 1. U.L. recognized.

High Density D-subminiature Connectors



ODD- LOW COST

76% CONTACT DENSITY INCREASE. **CONTACTS:** Fixed and removable. Precision machined of solid high tensile copper alloy; female contact is rugged "Robi-D open entry" design. Current rating to 5 amperes. Gold flash over nickel plate. Other finishes available upon request. **TERMINATIONS:** Crimp; solder cup; straight or right angle solder printed board mount.

INSULATORS: Glass-filled polyester, U.L. 94V-0. Six variants of 15, 26, 44, 62, 78 and 104 contacts. **SHELLS:** Steel and brass; tin plate and zinc or cadmium plate with chromate seal. **LOCKING SYSTEM:** Jackscrews and slide lock system. **CABLE ADAPTERS:** Hoods; metal, thermoplastic, composite, EMI/RFI. **MOUNTING:** Panel and printed board. **WORKING TEMPERATURE:** -55°C to +125°C. **CRIMPING TOOLS:** Automatic and manual. **MILITARY QUALIFICATIONS:** Compatible with connectors conforming to MIL-DTL-24308. U.L. and CSA recognized.

Baby King Cobra Circular Connectors



Miniature, Economical & Rugged Circular Connector Systems

CONTACTS: Removable or fixed. Precision machined of solid copper alloy. Screw termination contact is available. Current rating 7.5 amperes nominal. Gold flash over nickel plate. Other finishes available upon request. **TERMINATIONS:** Crimp; solder cup; straight and right angle solder printed board mount.

INSULATORS: Glass filled nylon, UL 94V-0. Two variants: three size 20, and 6 size 22. **POLARIZATION:** Provided by insulator. **LOCKING SYSTEM:** Threaded or Twist Locking Shroud. **CABLE ADAPTERS:** Hoods; nylon, IP65 with overmolded Assemblies (Consult Factory for details). **CABLIZED CONNECTORS:** Customer specified wire or cable can be supplied terminated to connector with cable adapters or over-molded cable assemblies. **MOUNTING:** Panel and printed board. **WORKING TEMPERATURE:** -55° to +125°C. **CRIMPING TOOLS:** Automatic and manual.

NORTH AMERICAN SALES OFFICES

United States, Springfield, Missouri
Factory and Sales Office
Puerto Rico Sales Office
Mexico Sales Office
Canada Sales Office

800 641 4054
800 641 4054
800 872 7674
800 327 8272

info@connectpositronic.com
info@connectpositronic.com
info@connectpositronic.com
info@connectpositronic.com

EUROPEAN SALES OFFICES

France, Auch Factory and Sales
Northern France Sales Office
Southern France Sales Office
Italy Sales Office
Germany Sales Office
United Kingdom Sales Office

33 (0) 5 6263 4491
33 (0) 1 4588 1388
33 (0) 6 8648 4023
39 (0) 2 5411 6106
49 (0) 23 5163 4739
44 (0) 7975 682 488

contact@connectpositronic.com
jchaloux@connectpositronic.com
pafon@connectpositronic.com
rmagni@connectpositronic.com
cbouche@connectpositronic.com
lbridwell@connectpositronic.com

Europe & Middle East Technical Agents:

Finland, United Kingdom, Scotland, Israel, Norway, Sweden, Turkey and the Ukraine.

ASIA/PACIFIC LOCATIONS

SINGAPORE, Asia/Pacific Headquarters

Factory Sales and Engineering Offices

+65 6842 1419

singapore@connectpositronic.com

ASIA, Direct Sales Offices

China

Factory - Zhuhai
Shenzhen
Shanghai
Xian Sales Office
Beijing Sales Office

+86 756 3626 466
+86 158 2907 9779
+86 158 2907 9779
+86 029 8839 5306
+86 10 8203 7718
+81 3 6310 5830

zhuhai@connectpositronic.com
shenzhen@connectpositronic.com
shanghai@connectpositronic.com
xian@connectpositronic.com
beijing@connectpositronic.com
japan@connectpositronic.com

Japan Sales and Engineering Offices

India

Factory Sales and Engineering Offices
Bangalore Sales Office
New Delhi Sales Office

+91 20 2469 9910
+91 94 4907 3251
+91 80107 11175

india@connectpositronic.com
bangalore@connectpositronic.com
delhi@connectpositronic.com

Korea Sales Office

+82 31 909 8047

korea@connectpositronic.com

Taiwan Sales Office

+886 2 2937 8775

taiwan@connectpositronic.com

ASIA/PACIFIC, Technical Agents

Technical Agents in Australia, Hong Kong, Malaysia, New Zealand, Philippines, Thailand and Vietnam.

POSITRONIC INDUSTRIES, INC

423 N Campbell Avenue, P O Box 8247,
Springfield, MO 65801, USA
Telephone: 1 417 866 2322
Fax: 1 417 866 4115
Email: info@connectpositronic.com

POSITRONIC INDUSTRIES, SAS

Zone Industrielle Est, 46 Route d'Engachies,
F32020, Auch Cedex 9, France
Telephone: 33 (0) 5 62 63 44 91
Telecopieur: 33 (0) 5 62 63 51 17
Email: contact@connectpositronic.com

POSITRONIC ASIA PTE LTD

3014A Ubi Road 1 # 07-01 Singapore 408703
Telephone: 65 6842 1419 Fax: 65 6842 1421
Email: singapore@connectpositronic.com

www.connectpositronic.com



POSITRONIC[®]
GLOBAL *Connector* SOLUTIONS

LOW PROFILE SCORPION

Slim Modular Power & Signal Contact Connectors