

# PANTHER

RUGGEDIZED IP65/IP67/IP68/IP69K WATERPROOF

- Designed for use in rail, earth moving, battery and related applications
- Meets EN45545-2 HL3 (R22/R23) requirements



Positronic®

THE SCIENCE OF **CERTAINTY**®

M04 Rev A 19/09



# Positronic

Positronic builds premium power and signal connectors for a variety of industries. But every product delivers a single outcome: *Certainty*.

Driven by the mission-critical needs of our customers, we've gone to school on the subject for over 50 years. We approach it with scientific discipline – honing the fusion of raw material, engineering ingenuity, and precision manufacturing to push the next limits of reliability.

And with every new project, our curiosity is reignited. How will certainty be achieved in your system, with its own unique demands? The answers have graced the most formidable missions of our time, from the fi es of super-sonic flight to the me ciless scapes of Mars.

## WHAT CAN YOU BE CERTAIN ABOUT?

- Rock-solid reliability
- Maximum design flexibilit
- High efficienc , low heat performance
- Responsive, knowledgeable support

THE SCIENCE  
OF **CERTAINTY**®

## TABLE OF CONTENTS

---

### Overview

Family Overview	1
Series Comparison	1

---

### Panther II

Overview	2
Tech Specs	2
Module Layouts	3
Dimensions	3
Contacts	4
Temperature Rise Curves	4
Create A Part	5

---

### Panther I



Overview	6
Tech Specs	7
Contact Layouts	7
Dimensions	7
Create A Part	7
Contacts	8
Temperature Rise Curves	8
Accessories	9

---



The **Panther** family of products, consisting of the **PA Series** and the **PB Series**, are rugged, waterproof connectors built for demanding applications. When your project calls for high power, shock and vibration resistance, or needs to meet fire, smoke and toxicity requirements for passenger applications, the **Panther** family can meet your requirements. The connectors can be used reliably in operating temperatures up to 200°C and are rated up to IP69. Trust the **Panther** family of connectors to deliver a reliable connection in any harsh environment.

## SERIES COMPARISONS

		POWER ONLY	POWER & SIGNAL	SIZE	IDEAL FOR
	<p><b>PANTHER I</b> - PA series</p> <p>Rugged IP65/67/68/69K connector for use in rail, earth moving, battery and related applications</p>	x	x	Medium	IP65/67/68/69K power and signal needs
	<p><b>PANTHER II</b> - PB series</p> <p>Large, high power, touch-safe connector for use in harsh environmental conditions</p>	x		Large	IP65/67/68/69K power and signal needs



The **Panther II** is designed for rugged, heavy duty applications where reliability cannot be comprised when operating in harsh environmental elements.

**Panther II** connectors are tested to meet rigorous salt spray, shock and vibration requirements. And when outdoor temperatures rise, the **Panther II** continues to provide a dependable connection, while resisting dust and water. If you need a reliable connector for your outdoor applications, **Panther II** delivers with its robust design, including a unique stainless steel locking mechanism for numerous mating cycles and trusted connections.

Trust the **Panther II** to deliver ***The Science of Certainty*** in mission-critical applications.

## TECH SPECS

### GENERAL

Part Number Prefix	PB
Performance Level	Mil/Aero Railway
Qualifications	UL*1 IEC safety standard Shock/Vibration testing standard EN45545-2 HL3 (R22) FAR 25.853 UV stability F1 grading Salt spray test

\*1 UL approval for layout 03. Contact Technical Sales for UL status on other variants.

### MATERIAL

Insulator Material	PEI
Insulator Color	Black
Flammability Rating	UL94 V-0
Contact Material	Copper alloy
Contact Plating	Gold flash 0.76µm Au 1.27µm Au

### ELECTRICAL

Working Voltage (rms)	1600 V
Initial Contact Resistance (max)	0.38 mΩ
Contact Current Rating at 30°C Temperature Rise per UL1977*1	Up to 110A*2
Contact Current Rating per UL1977*1	Up to 230A*2

\*1 See page 4 for temperature rise curves

\*2 Value established using high conductivity alloy

### MECHANICAL

Contact Style	Removable
Female Contact Design	Closed entry
Mating Cycles	500

### ENVIRONMENTAL

Operating Temperature	-55 to 160°C
Waterproof	IP65 IP67 IP68 IP69K

To download detailed product information, visit [www.connectpositronic.com/PantherII/ProductSpecs](http://www.connectpositronic.com/PantherII/ProductSpecs)

## MODULE LAYOUTS

Scale 1:1

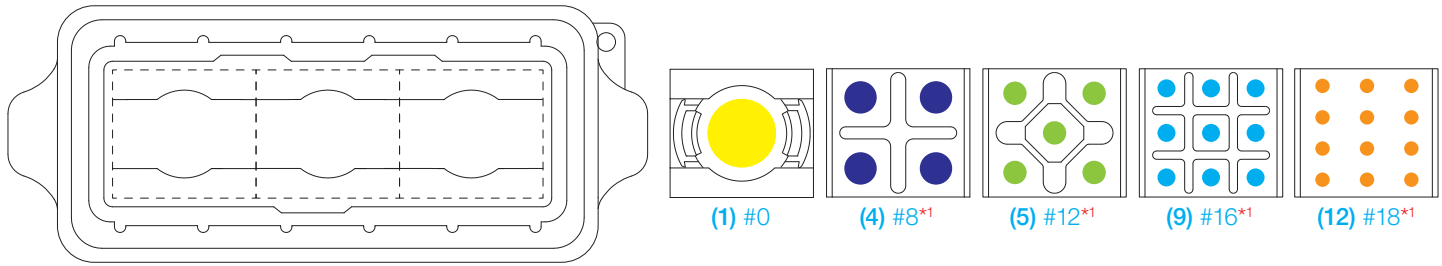

\*1 Contact Technical Sales for availability

Contact Size Chart				
#0	#8	#12	#16	#18

All Positronic products utilize solid, machined contacts.

## DIMENSIONS

For the sake of brevity, only basic dimensions of free cable male are shown here. Full dimensional detail is available in the respective product drawings.

Scale 1:1

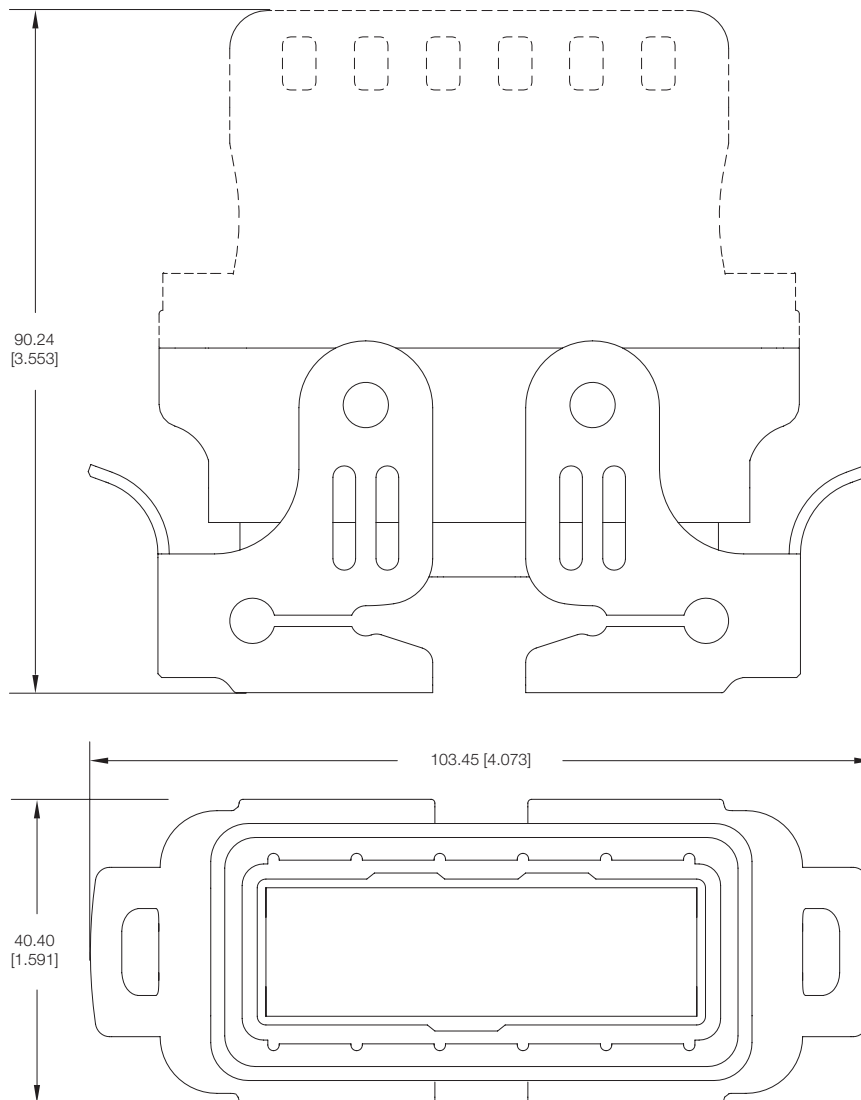

## CONTACTS

Contact Technical Sales for crimp contact part numbers not listed here.

PART NUMBER		Size	Gender	Female Contact Style	Stranded AWG [mm <sup>2</sup> ]
CN00-FXCRA-0001	SC	#0	Female	Closed entry	#0 [53.5]
CN00-FHCRA-0001	HC	#0	Female	Closed entry	#0 [53.5]
CN00-MXCRA-0001	SC	#0	Male	n/a	#0 [53.5]
CN00-MHCRA-0001	HC	#0	Male	n/a	#0 [53.5]

SC Standard conductivity contacts  
HC High conductivity contacts

## TEMPERATURE RISE CURVES

Tested per IEC Publication 60512-5-1, Test 5a

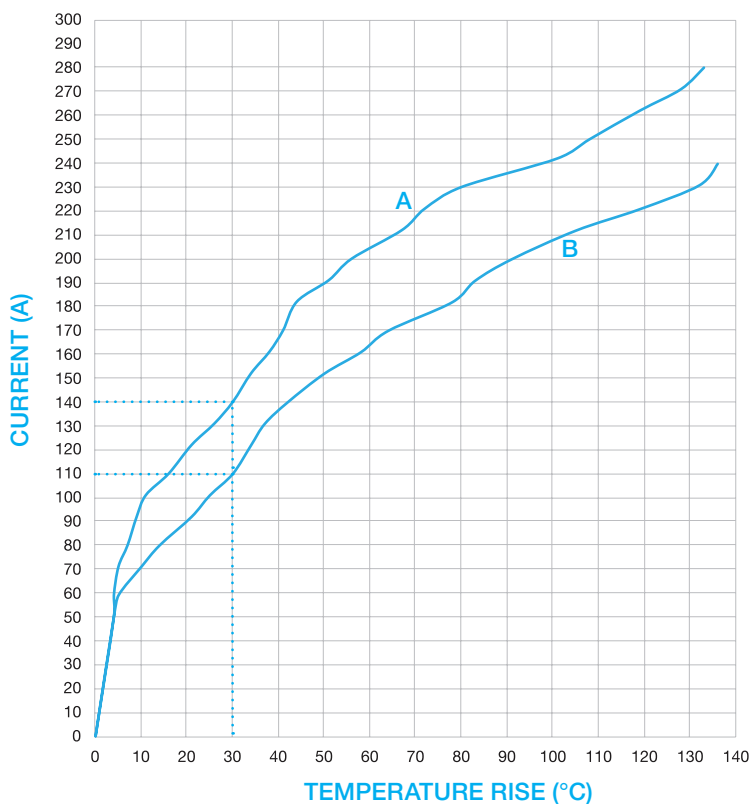

- A** Developed with (3) #0 high conductivity contacts with 0 AWG wire.
- B** Developed with (3) #0 standard conductivity contacts with 0 AWG wire.

## CREATE A PART

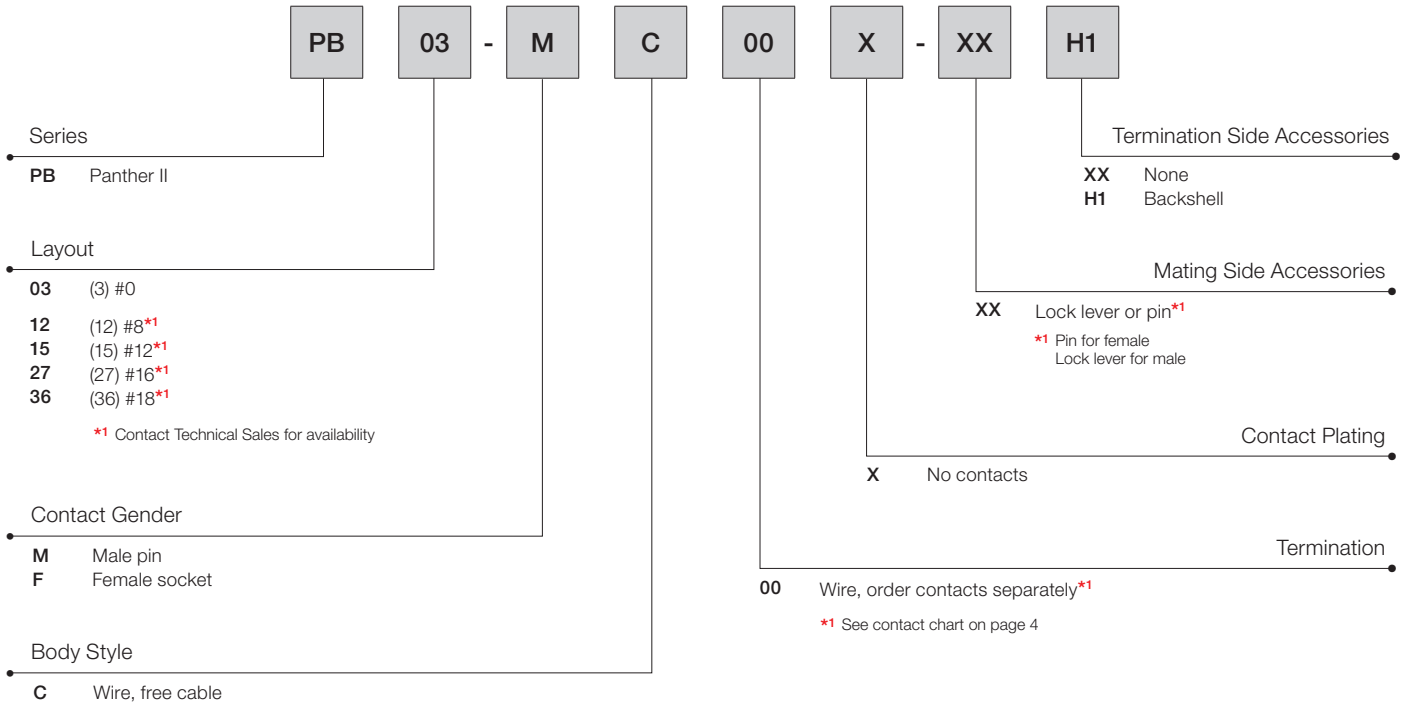



In the world of electronics, the ability of the equipment to withstand harsh environments is becoming increasingly critical. The **Panther I** addresses that need by offering up to IP69K sealing capability along with increased operating temperature ranges. It also meets smoke and toxicity requirements common in aerospace, rail and other passenger applications.

- IP65/IP67/IP68/IP69K in mated condition
- Operating temperatures up to 200°C
- Meets smoke and toxicity requirements

Trust the **Panther I** to deliver **The Science of Certainty** in mission-critical applications.

## TECH SPECS

### GENERAL

Part Number Prefix	PA
Performance Level	Industrial Mil/aero
Qualifications	UL*1 IEC safety standard Shock/Vibration testing standard EN45545-2 HL3 (R22/R23) FAR 25.853 NFF 16-101/102 Salt spray test

\*1 UL approval for layouts 03 and 08. Contact Technical Sales for UL status on other variants.

### MATERIAL

Insulator Material	LCP
Insulator Color	Black
Flammability Rating	UL94 V-0
Contact Material	Copper alloy
Contact Plating	Gold flash 0.76µm Au 1.27µm Au

### ELECTRICAL

Working Voltage (rms)	1600 V	
Initial Contact Resistance (max)	5 mΩ	
Contact Current Rating at 30°C Temperature Rise*1	Power Signal	Up to 45A*2 Up to 5A
Contact Current Rating per UL 1977*1	Power Signal	Up to 105A*2 Up to 5A

\*1 See page 8 for temperature rise curves

\*2 Value established using high conductivity alloy

### MECHANICAL

Contact Style	Fixed Removable
Female Contact Design	Closed entry
Mating Cycles	Up to 1000

### ENVIRONMENTAL

Operating Temperature	-55 to 200°C
UV Protection	Rated (f1) per UL 746C
Waterproof	IP65 IP67 IP68 IP69K

To download detailed product information, visit [www.connectpositronic.com/Panther/ProductSpecs](http://www.connectpositronic.com/Panther/ProductSpecs)



## CONTACT LAYOUTS

Scale 1:1

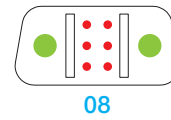
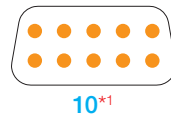
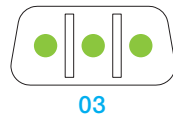
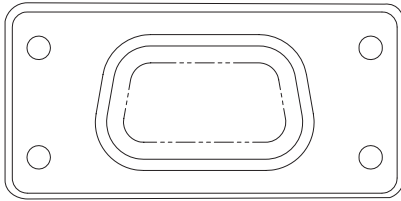

Contact Size Chart		
#12	#18	#22

All Positronic products utilize solid, machined contacts.

\*1 Contact Technical Sales for availability

## DIMENSIONS

For the sake of brevity, only basic dimensions of free cable male are shown here. Full dimensional detail is available in the respective product drawings.

Scale 1:1

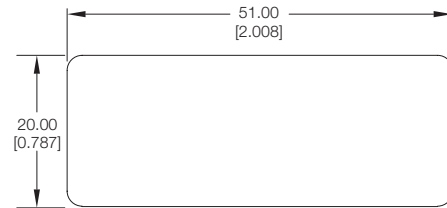
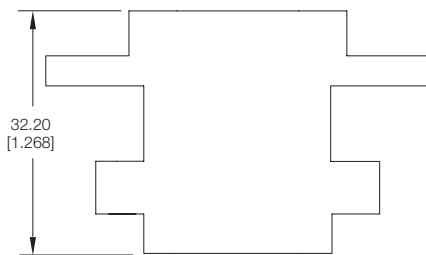

## CREATE A PART



Series

PA Panther I

Layout

03 (3) #12  
08 (2) #12, (6) #22  
10 (10) #18\*1

\*1 Contact Technical Sales for availability

Contact Gender

M Male pin  
S Female socket

Body Style

C Wire, free cable  
P Panel mount (wire or PCB)

Termination

00 Wire, order contacts separately\*1  
30 Straight solder  
31 Straight solder, high conductivity alloy\*2  
90 Straight press-fit\*3  
40 Right angle solder  
41 Right angle solder, high conductivity alloy\*2

\*1 See contact chart on page 8

\*2 High conductivity alloys are used on #18 contacts and larger

\*3 Contact Technical Sales for availability

Termination Side Accessories

XX None  
B1 Angle bracket (for use on right angle terminations)  
H1 Backshell (for use with wire terminations)

Mating Side Accessories

T2 Fixed female jackposts  
E2 Rotating male jackscrews, low profile, slotted

Contact Plating

X No contacts  
A Gold flash  
C 0.76  $\mu\text{m}$  [30 $\mu\text{in}$ ] min Au over Ni

## CONTACTS

Contact Technical Sales for crimp contact part numbers not listed here.

PART NUMBER		Size	Gender	Female Contact Style	Stranded AWG [mm <sup>2</sup> ]
FC1210P2/AA	SC	#12	Female	Closed entry	#10 [5.3]
FC1210P2S/AA	HC	#12	Female	Closed entry	#10 [5.3]
FC1212P2/AA	SC	#12	Female	Closed entry	#12 [4.0]
FC1212P2S/AA	HC	#12	Female	Closed entry	#12 [4.0]
MC1210N-PA563/AA	SC	#12	Male	n/a	#10 [5.3]
MC1210NS-PA563/AA	HC	#12	Male	n/a	#10 [5.3]
MC1212N-PA563/AA	SC	#12	Male	n/a	#12 [4.0]
MC1212NS-PA563/AA	HC	#12	Male	n/a	#12 [4.0]
FC1816P2/AA	SC	#18	Female	Closed entry	#16-18 [1.5-1.0]
FC1816P2S/AA	HC	#18	Female	Closed entry	#16-18 [1.5-1.0]
FC1820P2/AA	SC	#18	Female	Closed entry	#20 [0.5]
FC1820P2S/AA	HC	#18	Female	Closed entry	#20 [0.5]
MC1816N-PA561/AA	SC	#18	Male	n/a	#16-18 [1.5-1.0]
MC1816NS-PA561/AA	HC	#18	Male	n/a	#16-18 [1.5-1.0]
MC1820N-PA561/AA	SC	#18	Male	n/a	#20 [0.5]
MC1820NS-PA561/AA	HC	#18	Male	n/a	#20 [0.5]
FC422P9/AA	SC	#22	Female	Closed entry	#22-26 [0.30-0.12]
MC422N9-PA1007/AA	SC	#22	Male	n/a	#22-26 [0.30-0.12]

- SC Standard conductivity contacts
- HC High conductivity contacts

## TEMPERATURE RISE CURVES

Tested per IEC Publication 60512-5-2, Test 5a

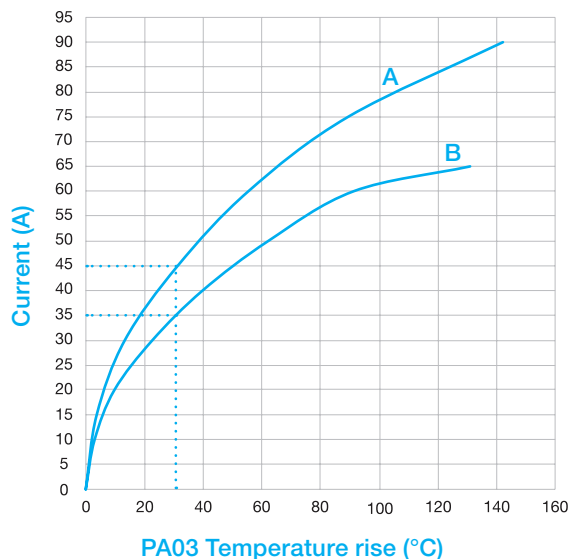

- A** Developed with (3) #12 high conductivity contacts with 10 AWG wire.
- B** Developed with (3) #12 standard conductivity contacts with 10 AWG wire.

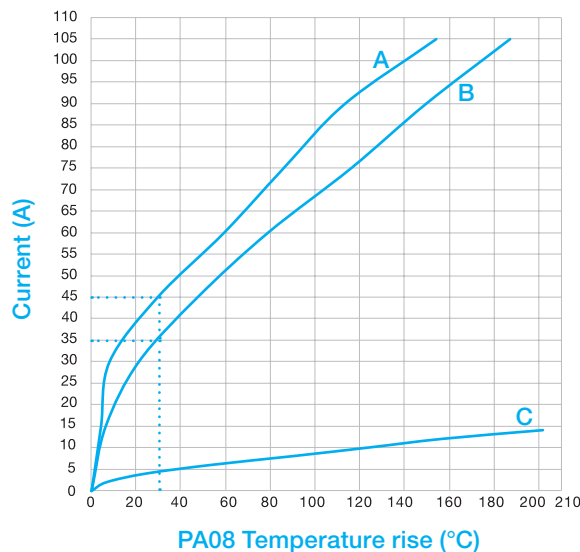

- A** Developed with (2) #12 high conductivity contacts with 10 AWG wire.
- B** Developed with (2) #12 standard conductivity contacts with 10 AWG wire.
- C** Developed with (2) #22 standard conductivity contacts with 22 AWG wire.

## BACKSHELL

**H1** (For use with wire termination)

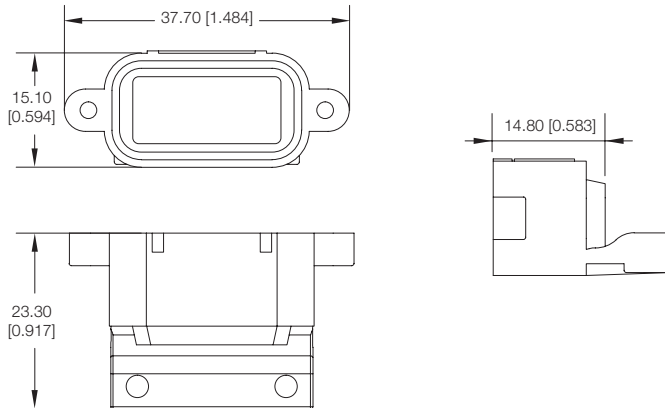

MATERIALS	
Backshell	LCP, black
Cable clamp	Stainless steel, passivated
Screws	Stainless steel, passivated



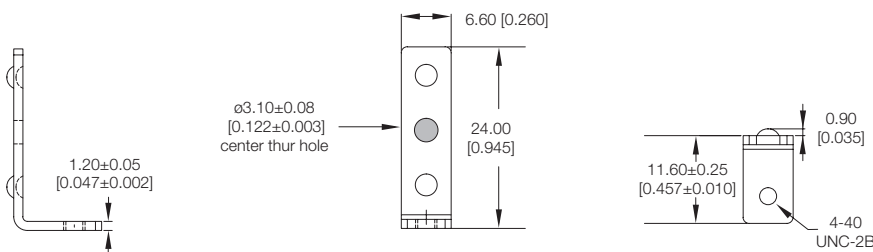
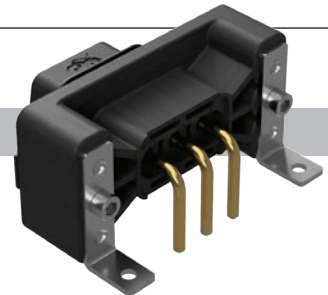

## ANGLE BRACKET

**B1** (For use with right angle)



MATERIALS	
Angle bracket	Stainless steel, passivated
Screws	Stainless steel, passivated

See [connectpositronic.com/Panther](http://connectpositronic.com/Panther) for all other Panther-related information including:

- ✓ Footprints 
- ✓ Tooling 
- ✓ Product updates 
- ✓ Detailed dimensions 
- ✓ 2D/3D drawings 

All dimensional tolerances are  $\pm 0.38$  [0.015], unless otherwise specified. Dimensions are in millimeter [inches]. All dimensions are subject to change. Product pictures may not be identical in appearance to actual production parts.

Information in this catalog is proprietary to Positronic and its subsidiaries. Positronic believes the data contained herein to be reliable. Since the technical information is given free of charge, the user employs such information at his own discretion and risk. Positronic assumes no responsibility for results obtained or damages incurred from use of such information in whole or in part.

The following trademarks are owned by Positronic Industries, Inc.: Positronic Industries, Inc.®, Positronic®, Connector Excellence®, P+ logo®, PosiBand®, PosiShop®, Optik-D™, and The Science of Certainty®. The color blue as it appears on various connectors is a trademark of Positronic Industries, Inc., Registered in U.S. Patent and Trademark Office

Products described within this catalog may be protected by one or more of the following US patents:

- #4,9000,261 #5,255,580 #5,329,697
- #7,115,002 #8,944,697 #9,304,263

Patented in Canada, 1992 Other patents pending

**Positronic | Americas**

423 N Campbell Ave  
Springfield MO 65806 USA  
+1 800 641 4054  
info@connectpositronic.com

**Positronic | Europe**

46 route d'Engachies  
F-32020 Auch Cedex 9 France  
+33 5 6263 4491  
contact@connectpositronic.com

**Positronic | Asia**

3014A Ubi Rd 1 #07-01  
+65 6842 1419  
Singapore 408703  
singapore@connectpositronic.com

**Sales Offices**

Positronic has local sales representation all over the world. For the nearest sales office visit [www.connectpositronic.com/sales](http://www.connectpositronic.com/sales)