



Actual size

Features

- Small (5.7 x 4.8 x 1.2mm)
- Proven and robust silicon MEMS vibrating ring gyro
- Low bias instability (24°/hr) over short integration period (<1s)
- Low Angular Random Walk (0.28°/√hr)
- In-plane, orthogonal and 20° inclined sensing options (CRM100, CRM200 and CRM120)
- User selectable dynamic ranges; 75°/s, 150°/s, 300°/s and 900°/s (maximum 1,000°/s)
- Analogue and Digital (SPI®) output modes
- User adjustable bandwidth to 160Hz
- 3V supply
- Low power consumption (4mA)
- High shock and vibration rejection
- Hermetically sealed ceramic LCC surface mount package for temperature and humidity resistance
- Integral temperature sensor
- Low integration cost
- Design tools and resources available
- RoHS compliant
- AEC Q100 tested

Applications

- Automotive in-car navigation
- Precision GPS vehicle and personal navigation aiding
- Vehicle yaw, pitch and roll rate sensing
- Gesture sensing
- Motion tracking
- Pointing devices
- Precision agriculture
- Antenna stabilisation
- Industrial and robotics

1 General Description

PinPoint® is a single-axis MEMS angular rate sensor (gyro) capable of measuring angular velocity up to a maximum of $\pm 1,000^\circ/\text{s}$ which has two output modes; an analogue voltage signal which is linearly proportional to angular speed, and a digital signal in SPI® protocol. The choice of output mode; analogue or digital, is determined by the user when connecting it to the user's host PCBA; details of the electrical interface between PinPoint® and the host PCBA are given in Section 7.

PinPoint® is available in several configurations; a) CRM100 which measures angular velocity about an axis perpendicular to the plane of the host PCBA, referred to as 'in-plane' sensing, b) CRM200 which measures angular velocity about an axis which is parallel to the plane of the host PCBA, referred to as 'orthogonal' sensing and c) CRM120 which measures angular velocity about an axis 20° off the perpendicular for applications where the host PCBA is a 20° an inclined angle. This datasheet relates to part number CRM100.

With a combination of CRM100 and CRM200 it is possible for the user to measure angular rate of multiple axes (e.g. any combination of pitch, yaw and roll) from a single host PCBA.

PinPoint® is supplied as a PCBA surface mountable LCC ceramic packaged device. It comprises five main components; silicon MEMS ring Sensor, Pedestal, ASIC, Package Base and Lid. More details of the construction are given in Section 13.

There are eight actuators / transducers distributed evenly around the perimeter of the silicon MEMS ring. Located about its primary axes are a single pair of 'primary drive' actuators and a single pair of 'primary pick-off' transducers. Located about its secondary axes (at 45° to the primary) are two pairs of 'secondary pick-off' transducers see Figure 1.1.

The 'primary drive' actuators and 'primary pick-off' transducers act together in a closed-loop system to excite and control the ring primary operating vibration amplitude and frequency.

Secondary 'pick-off' transducers detect radial movement at the secondary axes, the magnitude of which is proportional to the angular speed of rotation and from which the gyro derives angular rate.

More information about the principles of operation are given in Section 13.

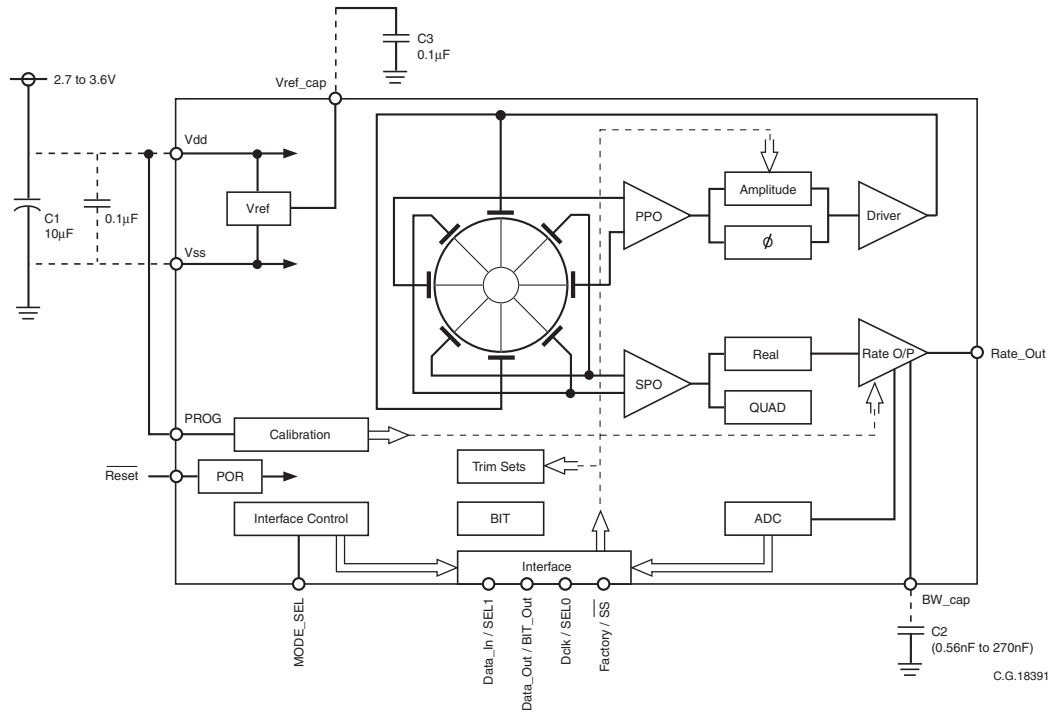

Figure 1.1 CRM100 Functional Block Diagram

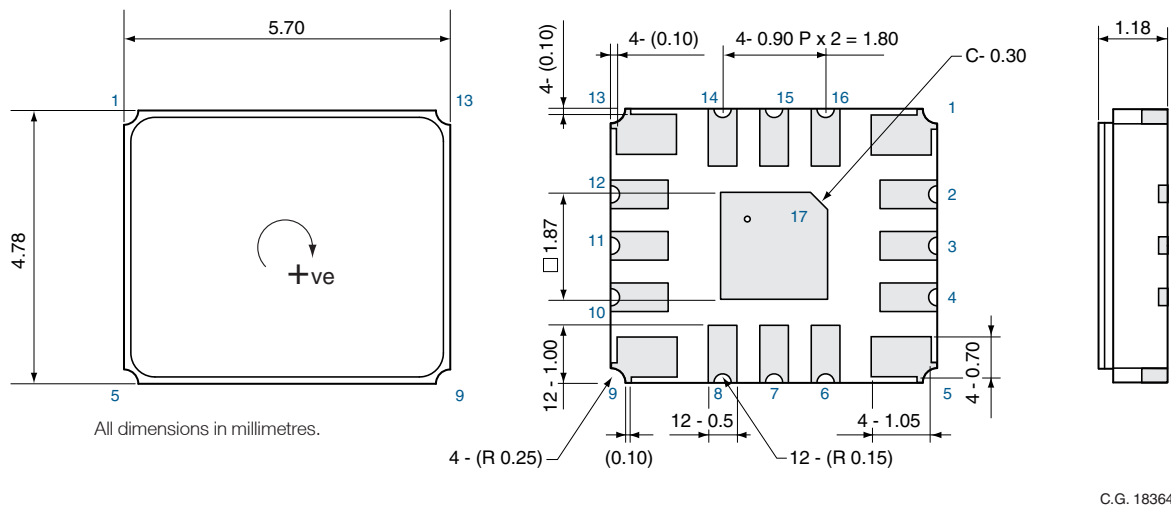

Figure 1.2 CRM100 Overall Dimensions

2 Ordering Information

Part Number	Sense Axis	Description	Measurement Range	Modes	Overall Dimensions	Supply Voltage
			°/s		mm	V
CRM100		Single-axis PinPoint® MEMS Gyroscope. Sensing axis perpendicular (in-plane) to the host PCBA.	User configured for ±75, ±150, ±300 & ±900	Analogue or Digital (User Configured)	5.7x4.8x1.2H	2.7 ~ 3.6
CRM120		Single-axis PinPoint® MEMS Gyroscope. Sensing axis at 20° (inclined) to the host PCBA.	User configured for ±75, ±150, ±300 & ±900	Analogue or Digital (User Configured)	5.7x5.0x4.9H	2.7 ~ 3.6
CRM200		Single-axis PinPoint® MEMS Gyroscope. Sensing axis parallel (orthogonal) to the host PCBA.	User configured for ±75, ±150, ±300 & ±900	Analogue or Digital (User Configured)	6.3x2.7x5.5H	2.7 ~ 3.6
400046-0100 (CRM100)		Gyro Evaluation Board for the CRM100 Single-axis PinPoint® MEMS Gyroscope (Includes the gyro). See Section 8 for more details	User configured for ±75, ±150, ±300 & ±900	Analogue	12x12x5H	2.7 ~ 3.6
400046-0200 (CRM200)		Gyro Evaluation Board for the CRM200 Single-axis PinPoint® MEMS Gyroscope (Includes the gyro). See Section 8 for more details	User configured for ±75, ±150, ±300 & ±900	Analogue	12x12x8.5H	2.7 ~ 3.6
400046-0300		3-axis Gyro Evaluation Board for the PinPoint® MEMS Gyroscope (Includes the gyros). See Section 8 for more details	User configured for ±75, ±150, ±300 & ±900	Analogue or Digital (User Configured)	25x25x8.5H	2.7 ~ 3.6

3 Specification

Unless stated otherwise, the following specification values assume Vdd = 3.0V and an ambient temperature of +25°C. 'Over temperature' refers to the temperature range -40°C to +85°C.

Parameter	Minimum	Typical	Maximum	Notes
Measurement Range:				
Dynamic Range	±75°/s, ±150°/s, ±300°/s, ±900°/s			User selectable Absolute limit 1,000°/s
Sensitivity:				
Analogue Output Mode Sensitivity:				
Scale Factor (k) (nominal)	For ±75°/s operation, k = 0.012 x Vdd/3 V/°/s For ±150°/s operation, k = 0.006 x Vdd/3 V/°/s For ±300°/s operation, k = 0.003 x Vdd/3 V/°/s For ±900°/s operation, k = 0.001 x Vdd/3 V/°/s		Ratiometric Ratiometric Ratiometric Ratiometric	See Section 7.1
Scale Factor variation at +25°C	-	±0.5%	-	-
Scale Factor variation over temperature	-3%	±1%	+3%	-

Specification Continued

Parameter	Minimum	Typical	Maximum	Notes
Scale Factor non-linearity	–	0.06%	0.2%	Percentage of dynamic range using a best straight line fit
Bias (nominal), +25°C	–	Vdd/2 ±12mV	–	–
Bias variation with temperature	-3°/s	–	+3°/s	–
Bias switch on repeatability	–	0.14°/s rms	–	–
Bias drift with time after switch on	–	0.05°/s/min	–	After 250 seconds
Bias instability	–	24°/hr (75°/s range) 40°/hr (900°/s range)	–	Allan Variance

Digital Output Mode Sensitivity:

Scale Factor (k) (nominal)	For ±75°/s operation, k = 96 LSB/°/s For ±150°/s operation, k = 48 LSB/°/s For ±300°/s operation, k = 24 LSB/°/s For ±900°/s operation, k = 8 LSB/°/s			Note: Digital output is <u>NOT</u> Ratiometric
Scale Factor variation at +25°C	–	±0.5%	–	–
Scale Factor variation over temperature	-3%	±1%	+3%	–
Scale Factor non-linearity	–	0.16%	0.2%	Percentage of dynamic range using a best straight line fit
Bias (nominal), +25°C	–	0000 ₁₀ ±96 ₁₀ LSB	–	–
Bias variation with temperature	-3°/s	–	+3°/s	–
Bias switch on repeatability	–	0.14°/s rms	–	–
Bias drift with time after switch on	–	0.05°/s/min	–	After 250 seconds
Bias instability	–	24°/hr (75°/s range) 40°/hr (900°/s range)	–	Allan Variance

Noise:

Rate noise density	–	0.018°/s/√Hz	0.025°/s/√Hz	–
Angular Random Walk	–	0.28°/√hr	–	Allan Variance

Frequency Response:

Bandwidth	5Hz	–	160Hz	User selectable see Section 7.5
-----------	-----	---	-------	---------------------------------

Temperature Sensor:

Offset	–	0512 ₁₀	–	Digital output only Nominal for 0°C
--------	---	--------------------	---	--

Specification Continued

Parameter	Minimum	Typical	Maximum	Notes
Scale factor	–	2.75 LSB/°C	–	–
+25°C typical output	–	600 ₁₀ ±20 ₁₀	–	–
Start Up:				
Time to full performance	–	300ms (Vdd=2.7V) 250ms (Vdd=3.6V)	1s	–
Physical:				
Mass	–	0.1g	–	–
Misalignment (Cross-axis Sensitivity)	-11 mrad	–	+11 mrad	This equates to a cross-axis sensitivity of approximately 1%
Misalignment over temperature	–	0.03 mrad/°C	–	–
Environmental:				
Temperature (Operating, full spec)	-40°C	–	+85°C	Gyro will function at full specification
Temperature (Operating, reduced spec)	-40°C	–	+105°C	Gyro will function at reduced performance
Temperature (Storage)	-60°C	–	+125°C	–
Humidity	–	–	85% RH	Non-condensing
Shock (operating)	–	–	500g 1ms	–
Shock (survival)	–	–	10,000g 0.1ms	–
Vibration rectification error	–	0.001°/s/g ² _{rms}	0.003°/s/g ² _{rms}	12g _{rms} stimulus, 10Hz to 5kHz, random
Vibration induced noise	–	0.06°/s _{rms} /g ² _{rms}	0.072°/s _{rms} /g ² _{rms}	12g _{rms} stimulus, 10Hz to 5kHz, random
Linear Acceleration:				
g sensitivity	–	0.077°/s/g	0.17°/s/g	Steady state
Electrical:				
Supply voltage	2.7V	3.3V (nom)	3.6V	Ramp rate should be greater than 1V/ms
Current consumption (inrush - during start-up)	–	–	12mA	Excluding charging decoupling capacitors
Current consumption (operating - after start-up)	–	4.0mA	5.0mA	–
Interface:				
SPI® message rate	500Hz	1kHz	10kHz	–
SPI® clock rate	100kHz	1MHz	8MHz	–
CBIT offset	–	+50%/s	–	±10%/s nominal tolerance

4 Absolute Minimum/Maximum Ratings

	Minimum	Maximum
Angular Velocity:		
Powered (saturated)	–	150,000°/s
Unpowered	–	No limit
Angular Acceleration:		
Powered	–	24,000°/s ²
Unpowered	–	No limit
Linear Acceleration (any axis):		
Powered	–	3,500g
Unpowered	–	10,000g 0.1ms
Electrical:		
Vdd	-0.3V	+4.0V
ESD protection	–	2kV HBM (except PROG pin) 1kV HBM PROG pin 200V MM
Duration of short circuit on any pin (except Vdd)	–	No limit
Temperature:		
Operating	-40°C	+105°C
Max storage (survival)	–	+125°C
Humidity	–	85% RH non-condensing

Notes:

Improper handling, such as dropping onto hard surfaces, can generate very high shock levels in excess of 10,000g. The resultant stresses can cause permanent damage to the sensor.

Exposure to the Absolute Maximum Ratings for extended periods may affect performance and reliability.

5 Typical Performance Characteristics

Graphs showing typical performance characteristics for PinPoint[®] are shown below:

Analogue Output Mode - Vdd = 3V, measurement range = 75°/s

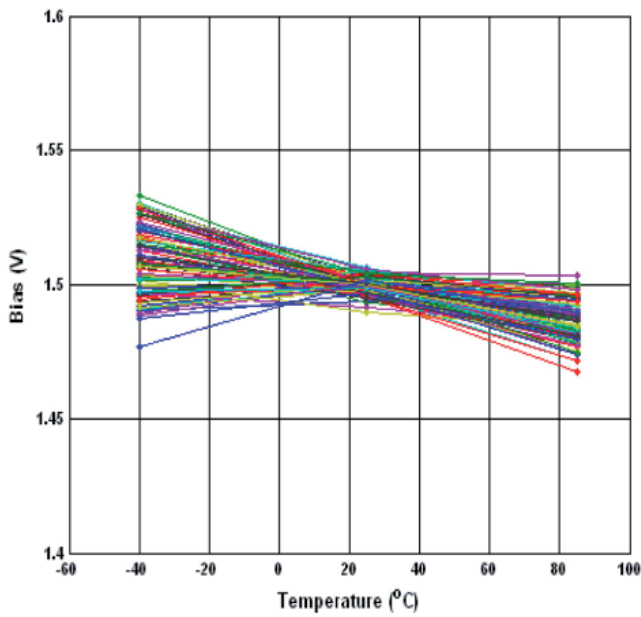

Figure 5.1 Analogue Bias vs Temperature (12 mV/°/s nominal)

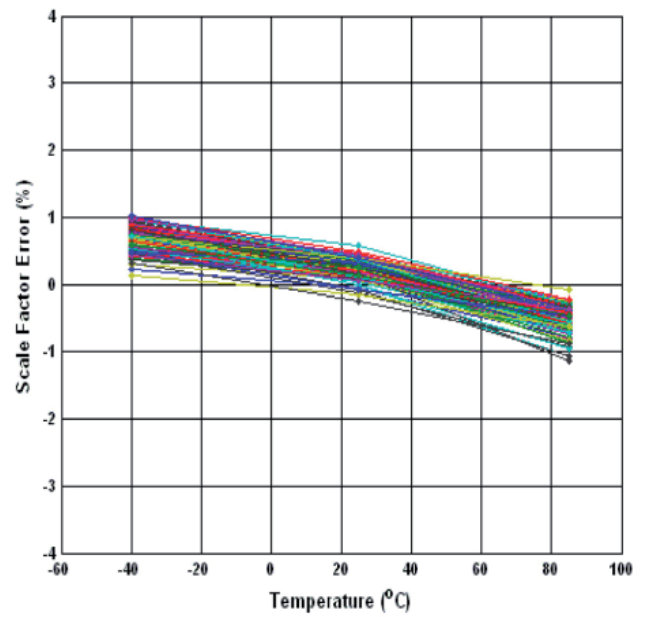

Figure 5.3 Analogue Scale Factor Error (12 mV/°/s nominal) vs Temperature

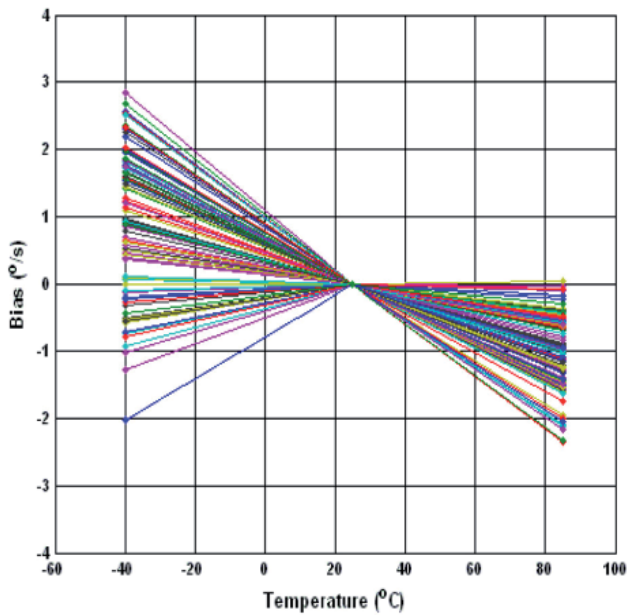

Figure 5.2 Normalized Analogue Bias vs Temperature

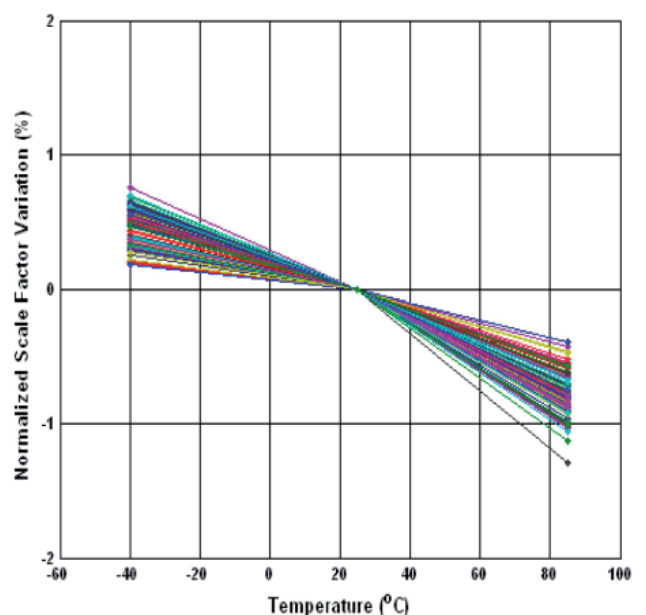

Figure 5.4 Normalized Analogue Scale Factor Variation vs Temperature

Analogue Output Continued

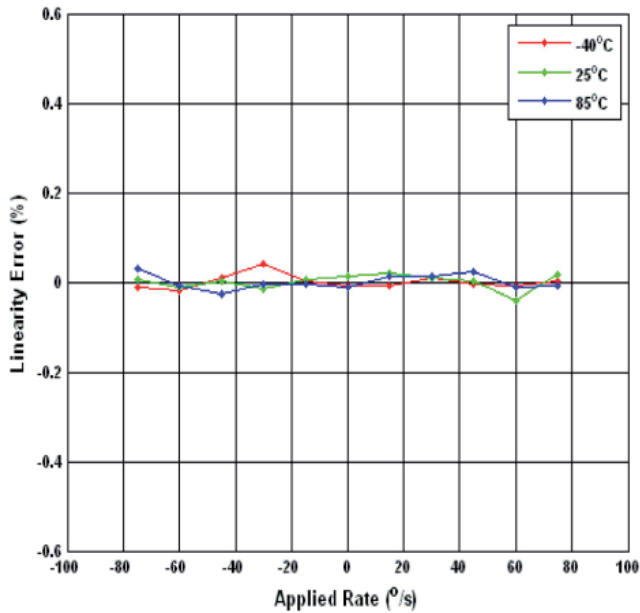

Figure 5.5 Typical Analogue Output Linearity Error vs Applied Rate

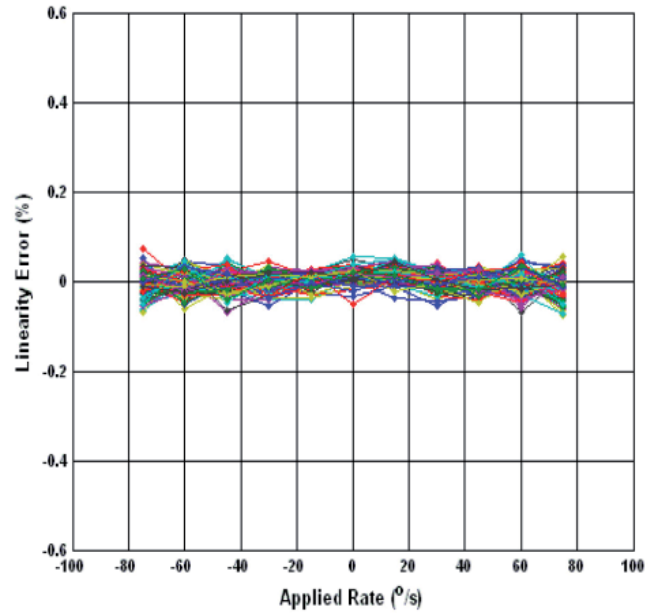

Figure 5.7 Analogue Output Linearity Error vs Applied Rate at +25°C

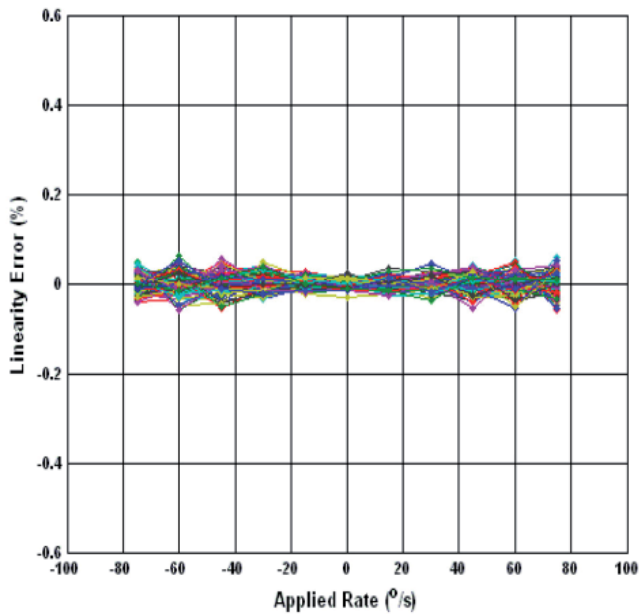

Figure 5.6 Analogue Output Linearity Error vs Applied Rate at -40°C

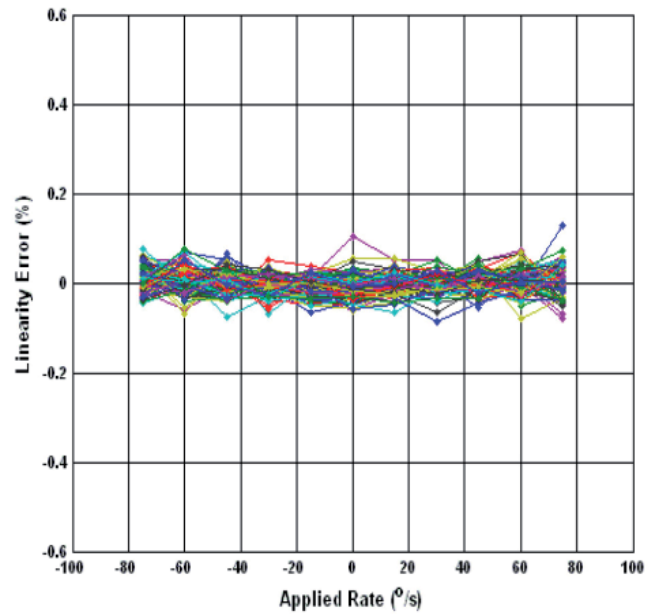

Figure 5.8 Analogue Output Linearity Error vs Applied Rate at +85°C

Analogue Output Continued

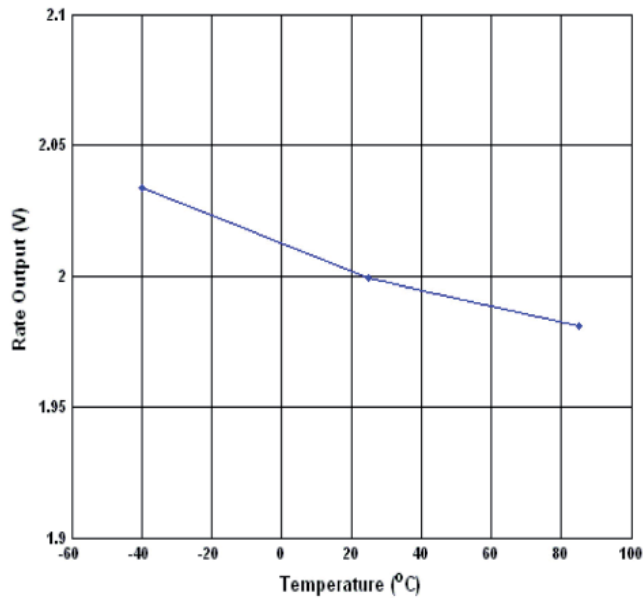

Figure 5.9 Typical Rate Output with Analogue CBIT vs Temperature

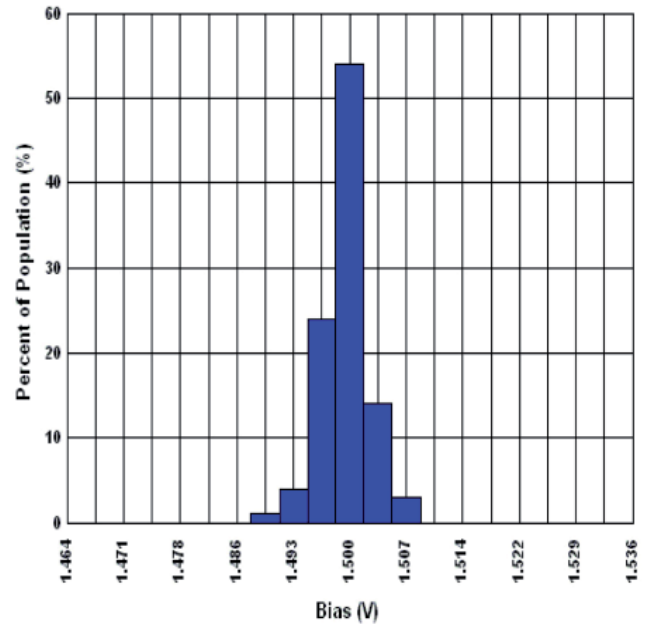

Figure 5.11 Analogue Bias at +25°C

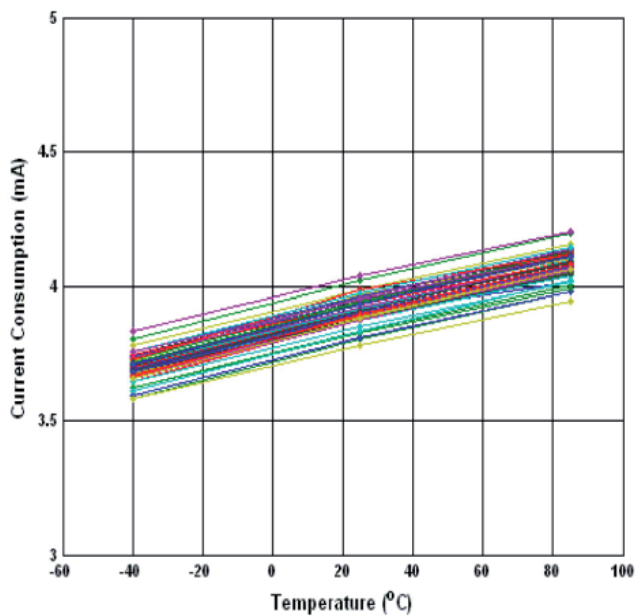

Figure 5.10 Current Consumption vs Temperature

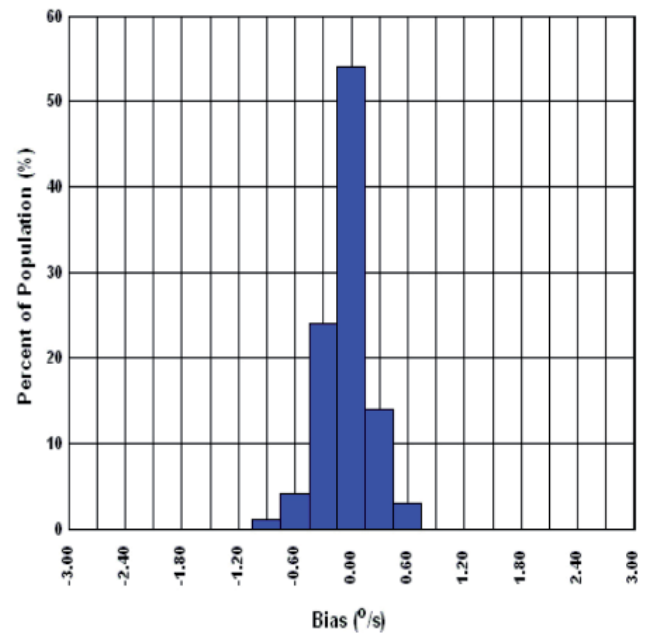

Figure 5.12 Analogue Bias at +25°C

Analogue Output Continued

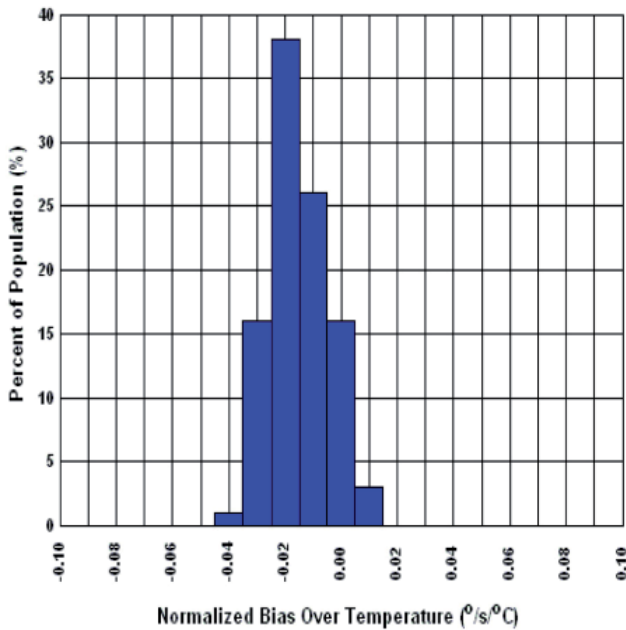

Figure 5.13 Normalized Analogue Bias Over Temperature

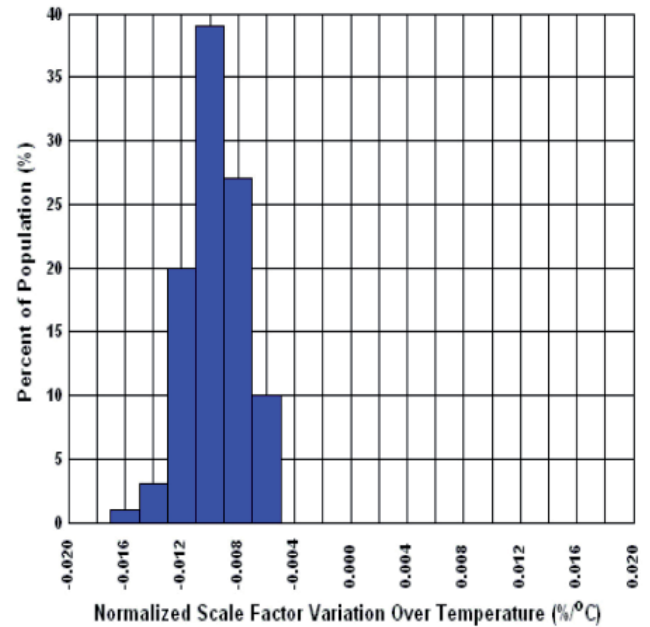

Figure 5.15 Normalized Analogue Scale Factor Variation Over Temperature

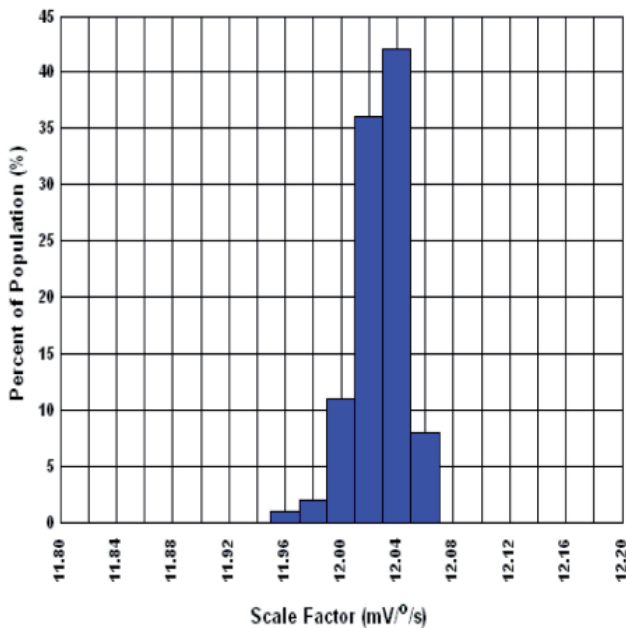

Figure 5.14 Analogue Scale Factor at +25°C

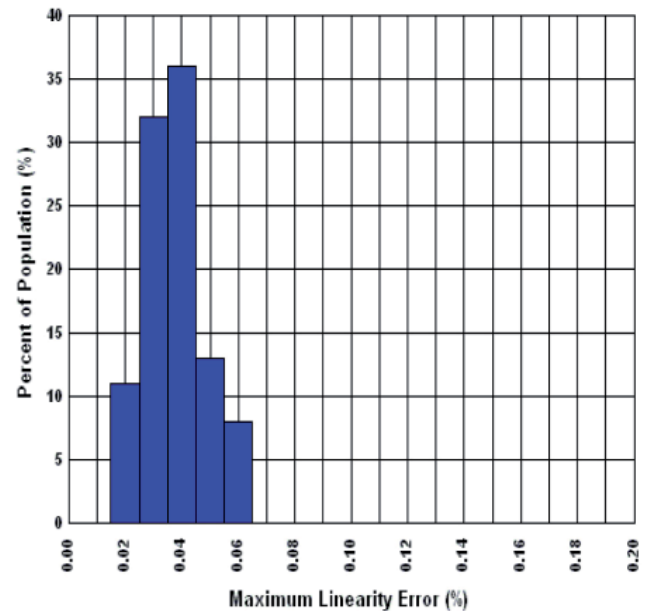

Figure 5.16 Analogue Output Maximum Linearity Error at -40°C (Best Straight Line Fit)

Analogue Output Continued

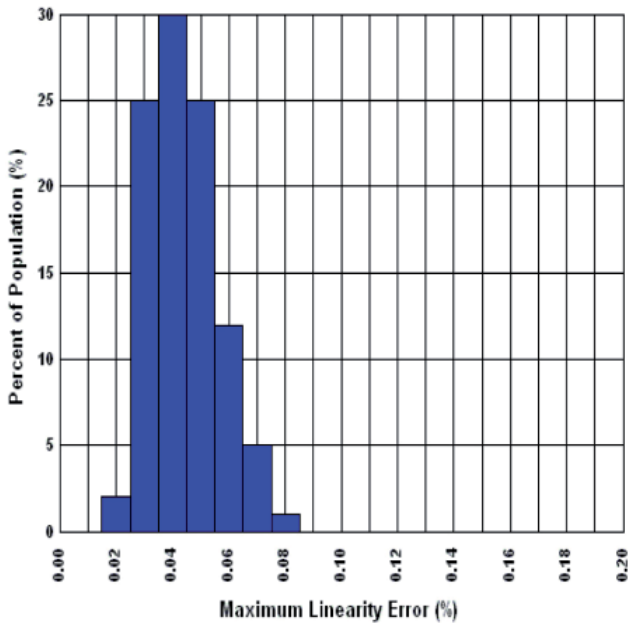

Figure 5.17 Analogue Output Maximum Linearity Error at +25°C (Best Straight Line Fit)

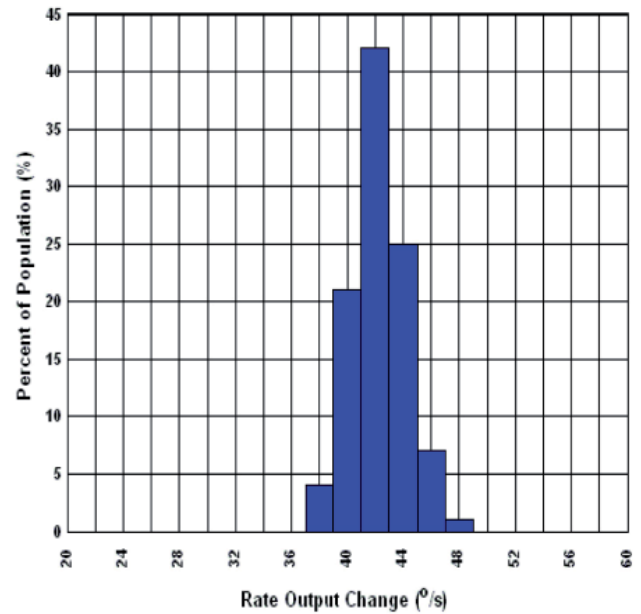

Figure 5.19 Rate Output Change with Analogue CBIT at +25°C

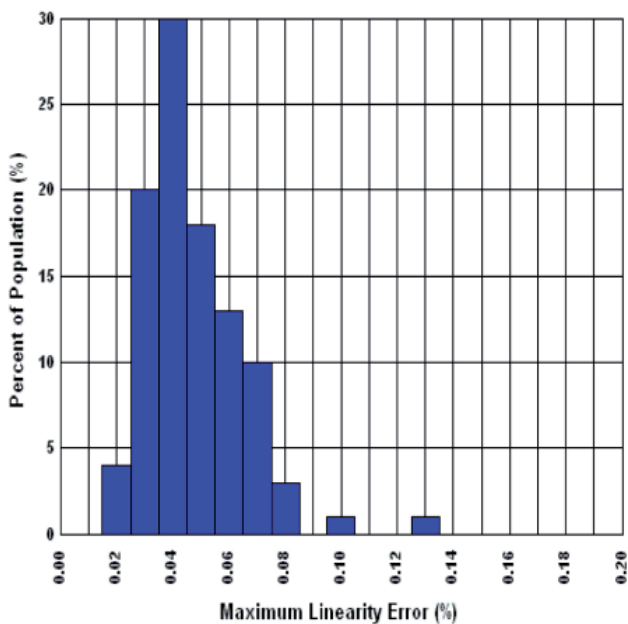

Figure 5.18 Analogue Output Maximum Linearity Error at +85°C (Best Straight Line Fit)

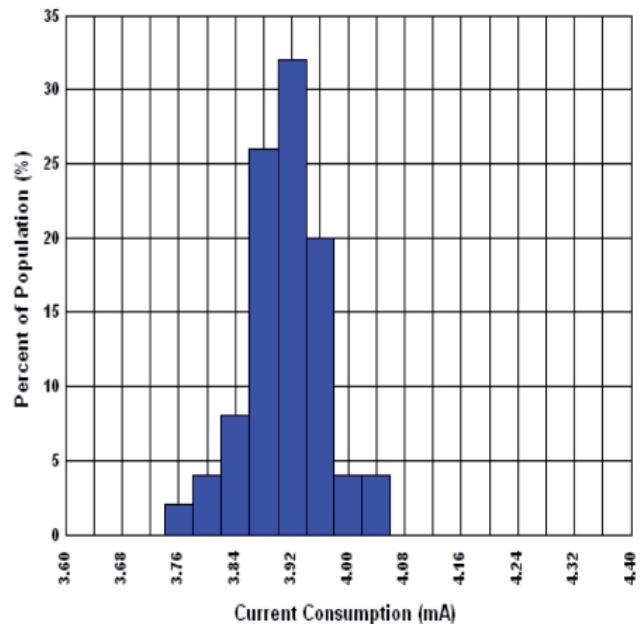

Figure 5.20 Current Consumption at +25°C

Digital Output Mode

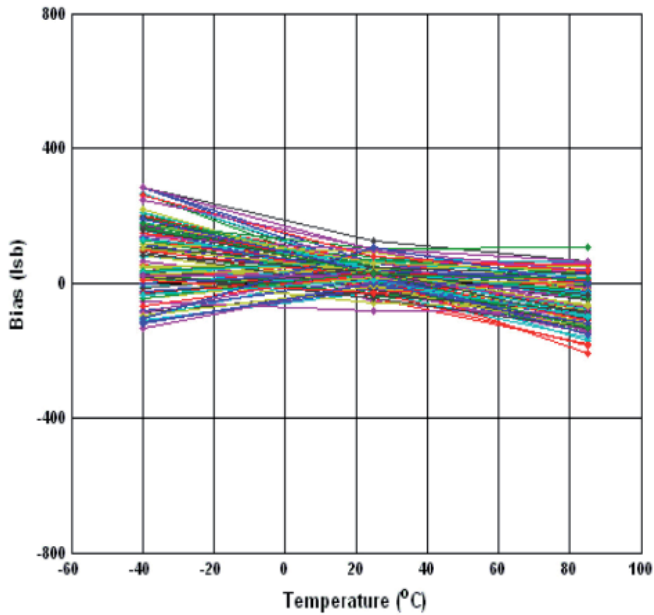

Figure 5.21 Digital Bias vs Temperature

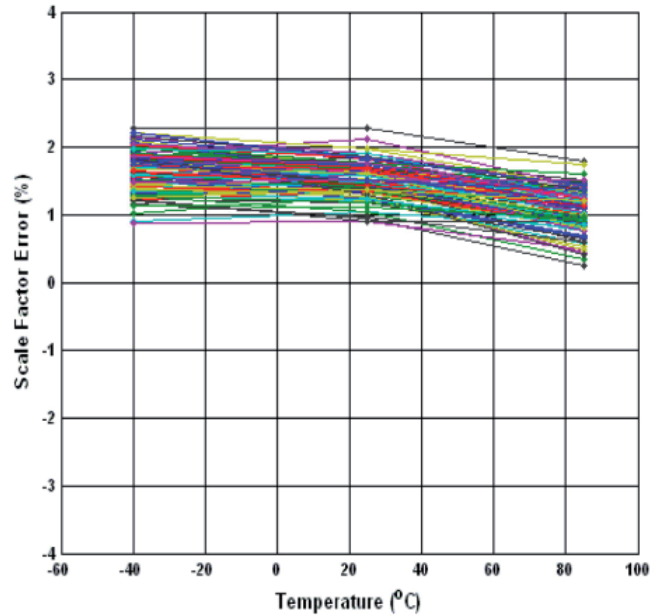

Figure 5.23 Digital Scale Factor Error (96 lsb/°/s nominal) vs Temperature

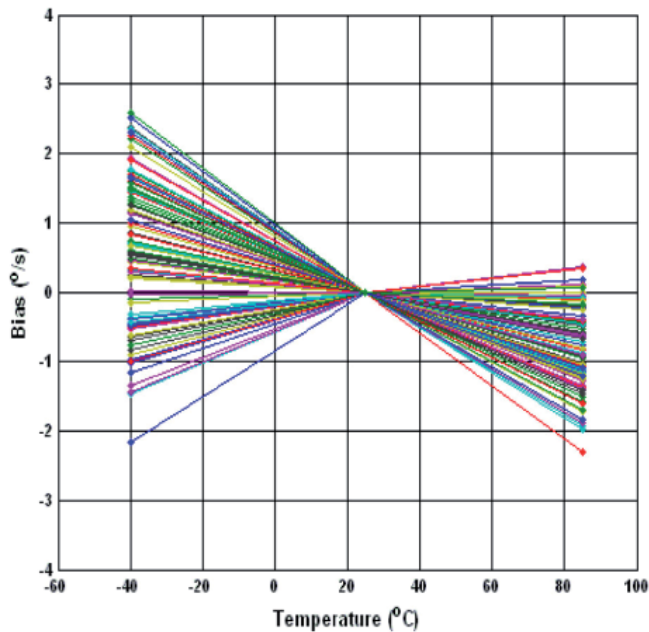

Figure 5.22 Normalized Digital Bias vs Temperature

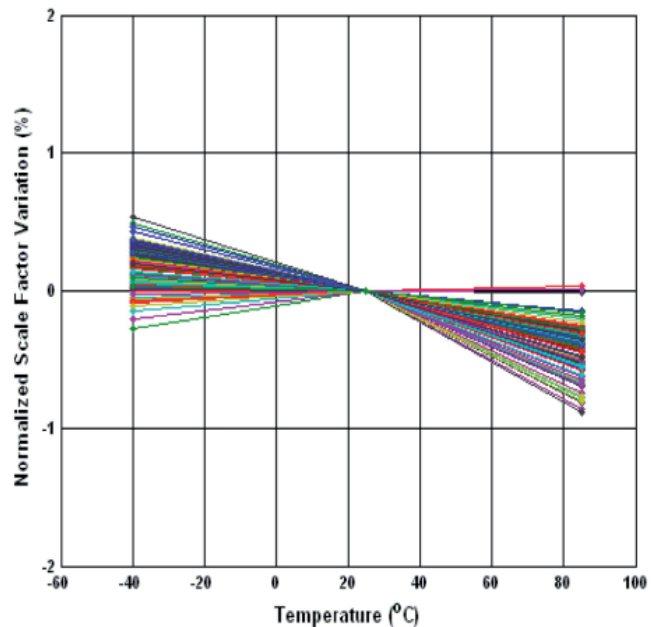

Figure 5.24 Normalized Digital Scale Factor Variation vs Temperature

Digital Output Continued

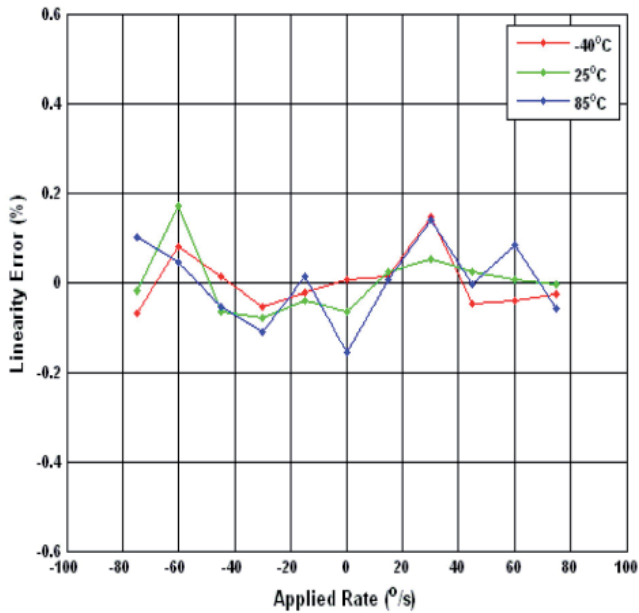

Figure 5.25 Typical Digital Output Linearity Error vs Applied Rate

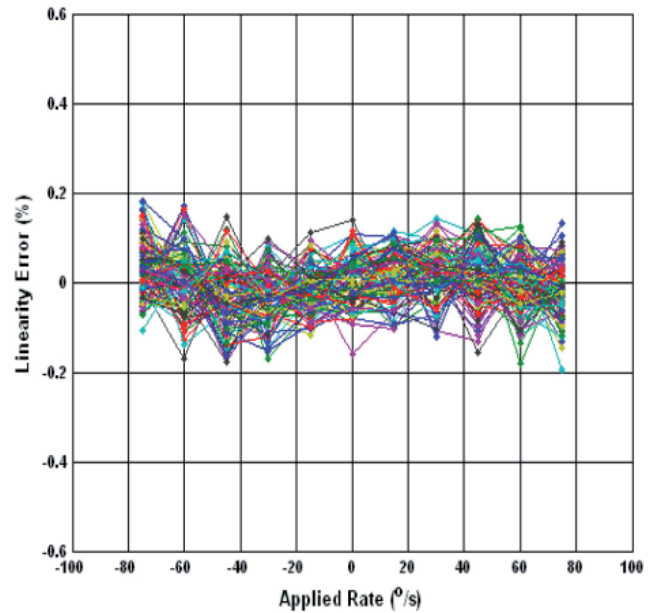

Figure 5.27 Digital Output Linearity Error vs Applied Rate at +25°C

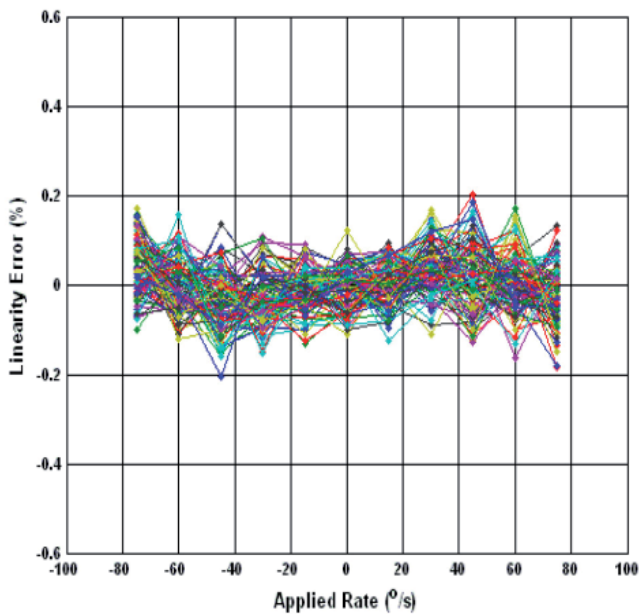

Figure 5.26 Digital Output Linearity Error vs Applied Rate at -40°C

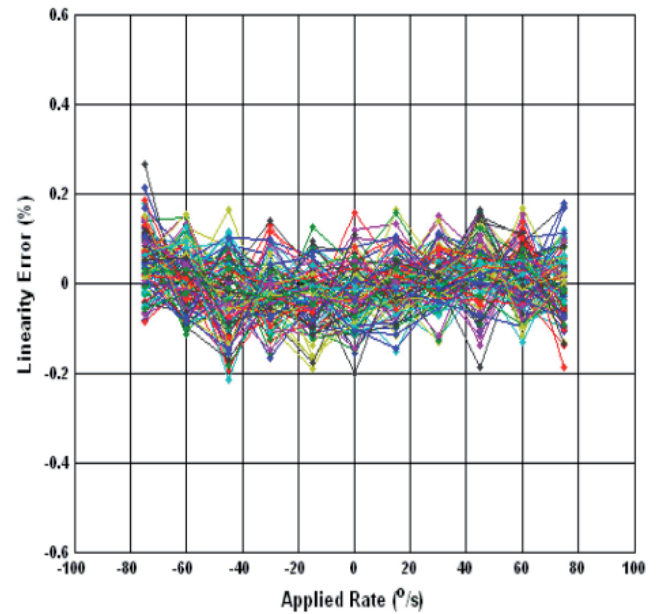

Figure 5.28 Digital Output Linearity Error vs Applied Rate at +85°C

Digital Output Continued

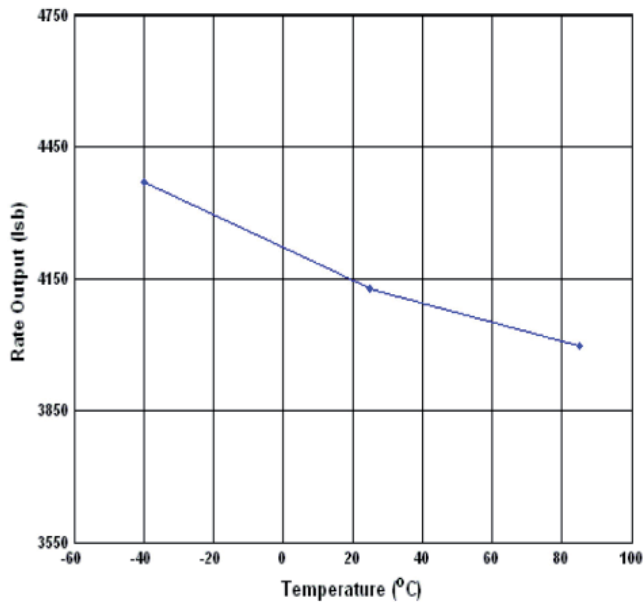

Figure 5.29 Typical Rate Output with Digital CBIT vs Temperature

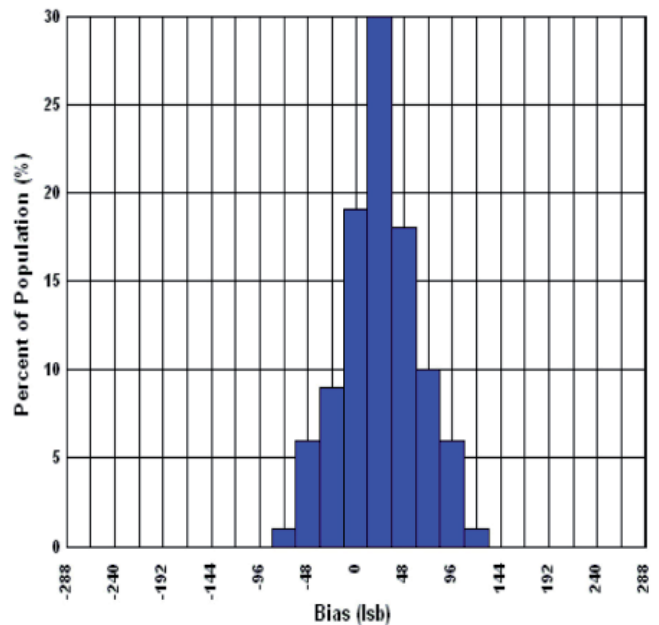

Figure 5.31 Digital Bias at +25°C

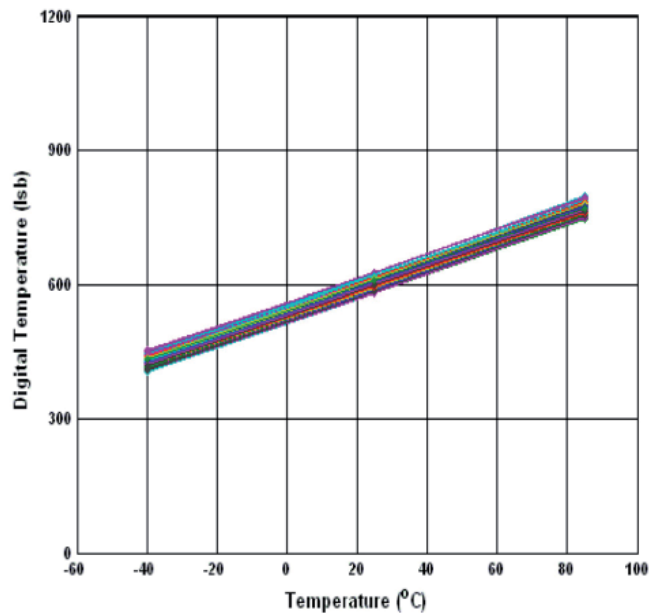

Figure 5.30 Digital Temperature vs Temperature

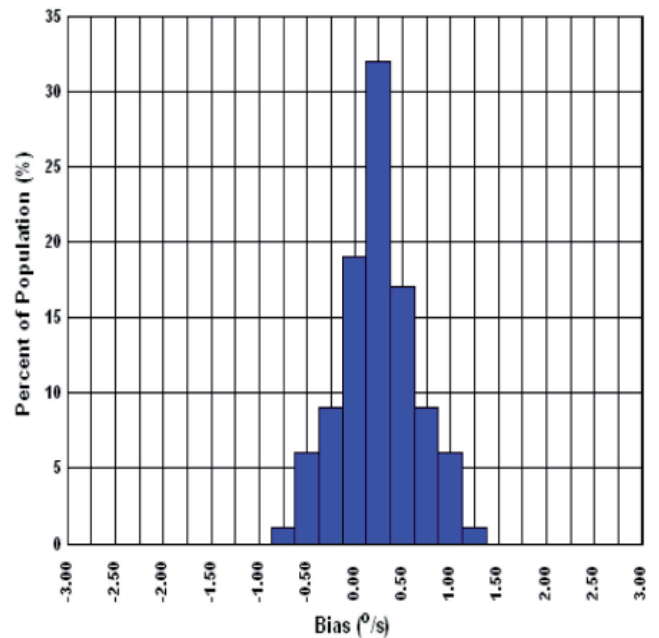

Figure 5.32 Digital Bias at +25°C

Digital Output Continued

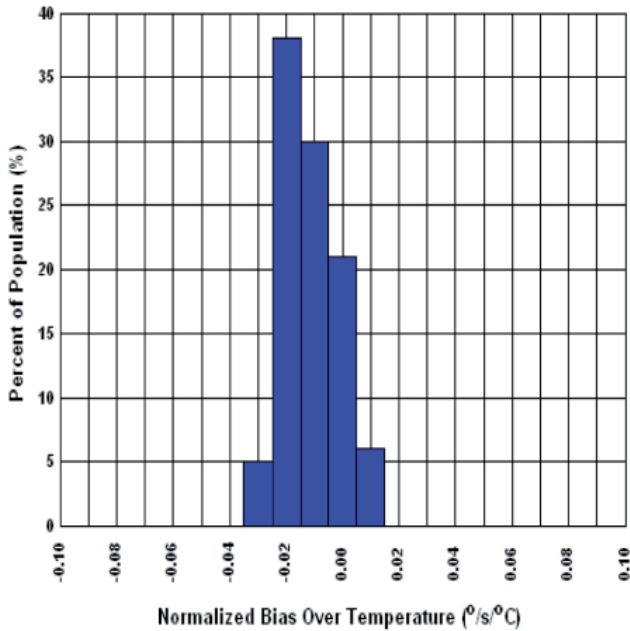

Figure 5.33 Normalized Digital Bias Over Temperature

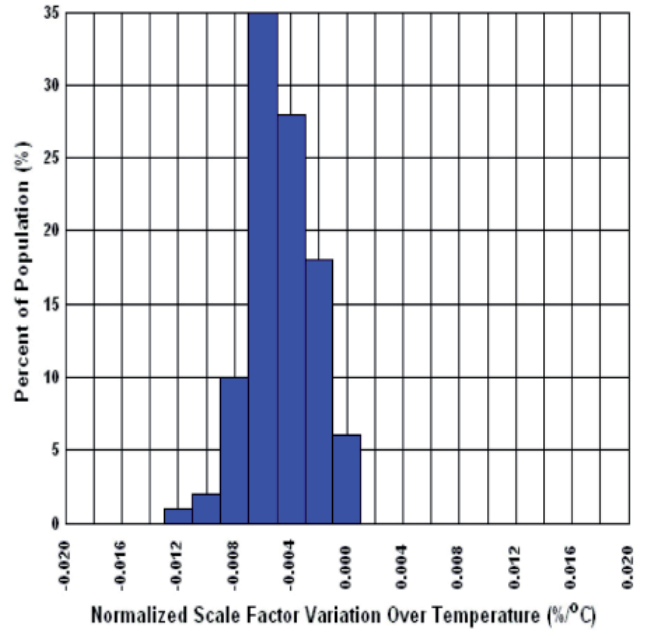

Figure 5.35 Normalized Digital Scale Factor Variation Over Temperature

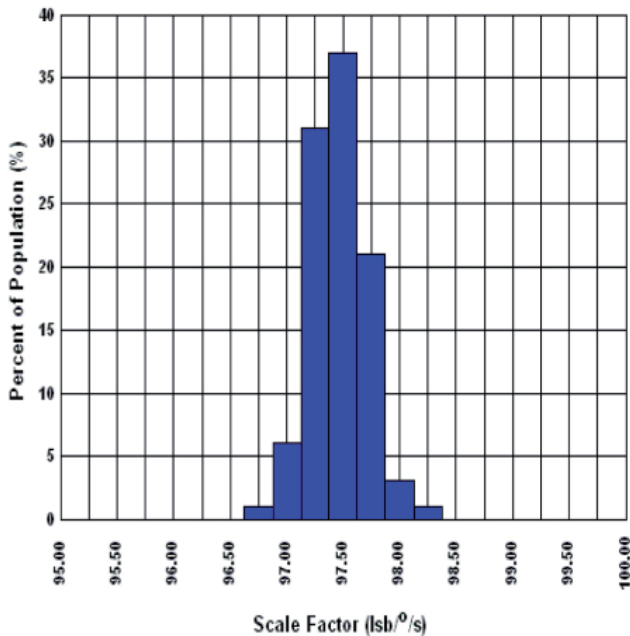

Figure 5.34 Digital Scale Factor at +25°C

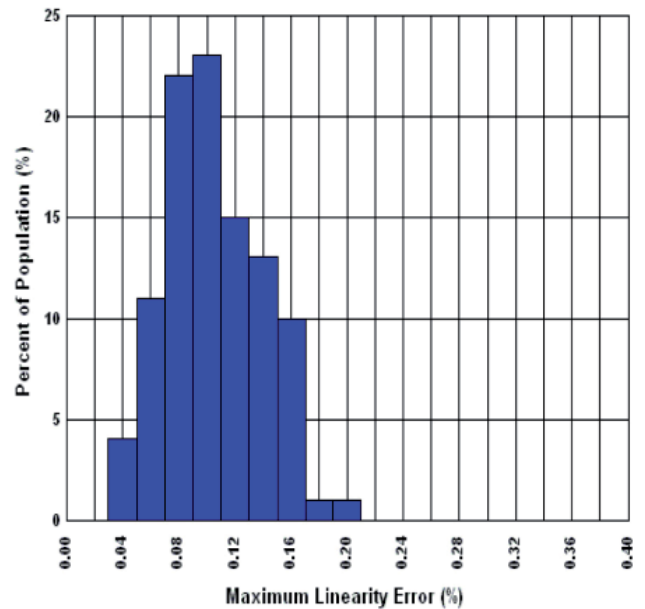

Figure 5.36 Digital Output Maximum Linearity Error at -40°C (Best Straight Line Fit)

Digital Output Continued

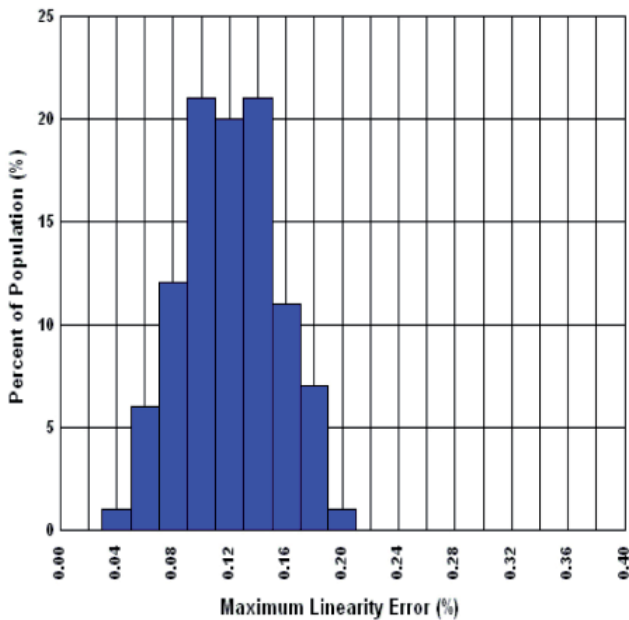

Figure 5.37 Digital Output Maximum Linearity Error at +25°C (Best Straight Line Fit)

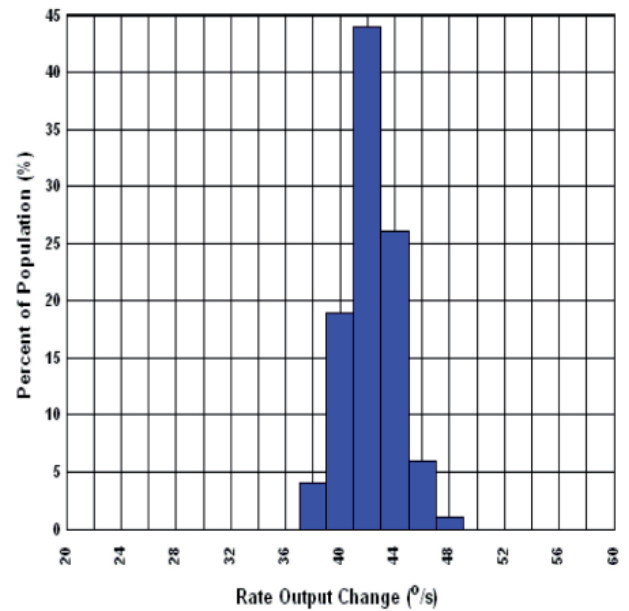

Figure 5.39 Rate Output Change with Digital CBIT at +25°C

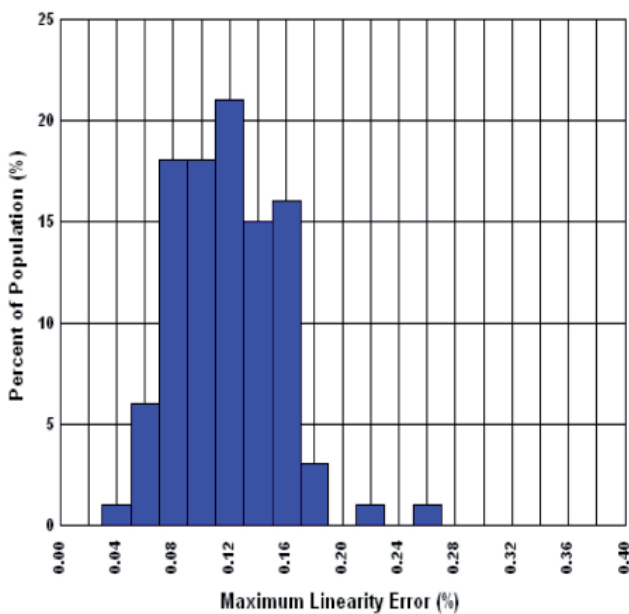

Figure 5.38 Digital Output Maximum Linearity Error at +85°C (Best Straight Line Fit)

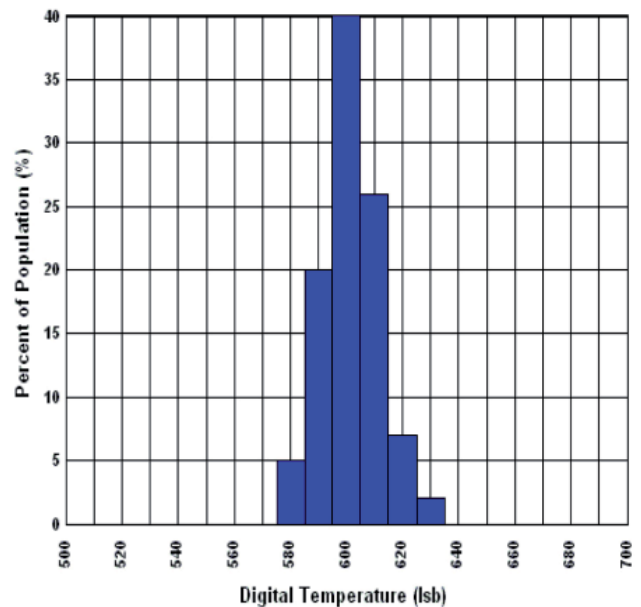

Figure 5.40 Digital Temperature at +25°C

Startup

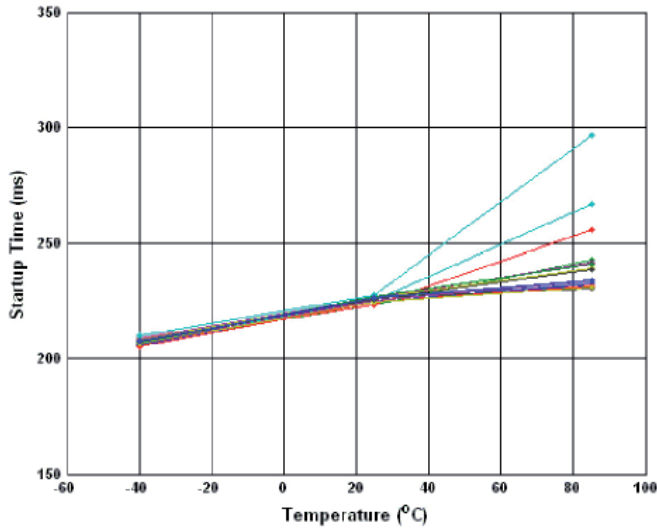

Figure 5.41 Startup Time vs Temperature (Vdd = 2.7V)

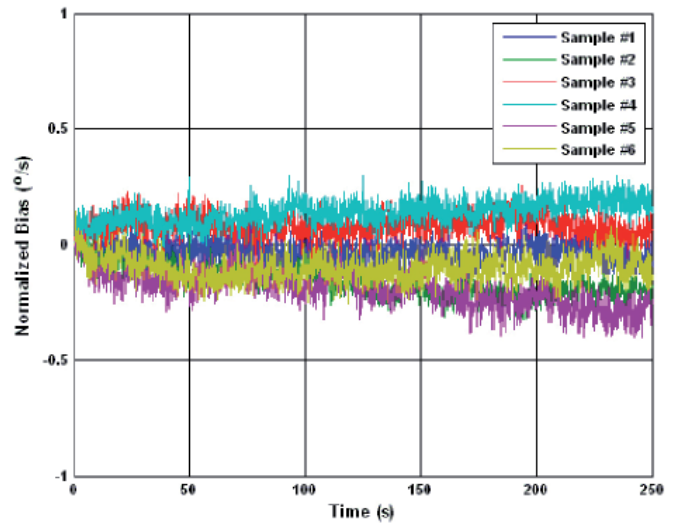

Figure 5.43 Normalized Bias Drift after Switch-On

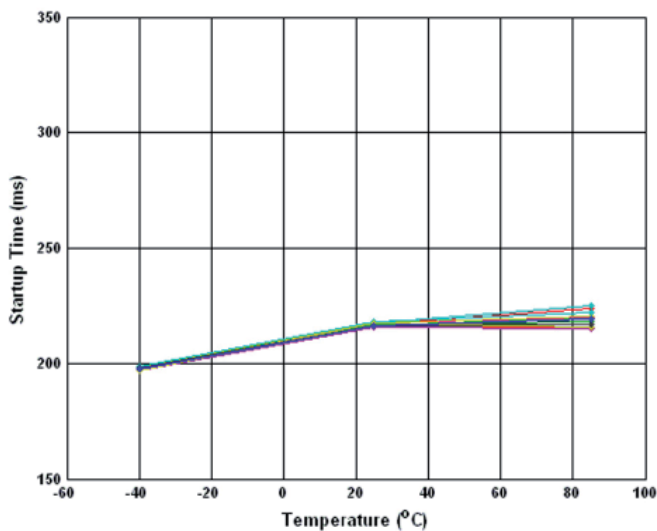

Figure 5.42 Startup Time vs Temperature (Vdd = 3.6V)

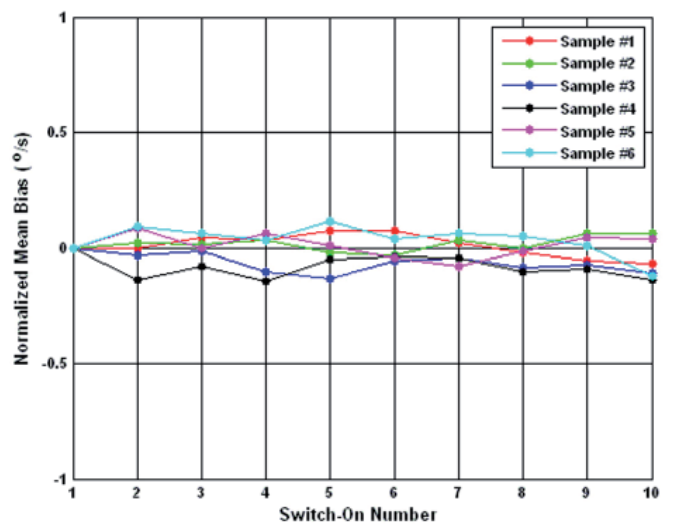
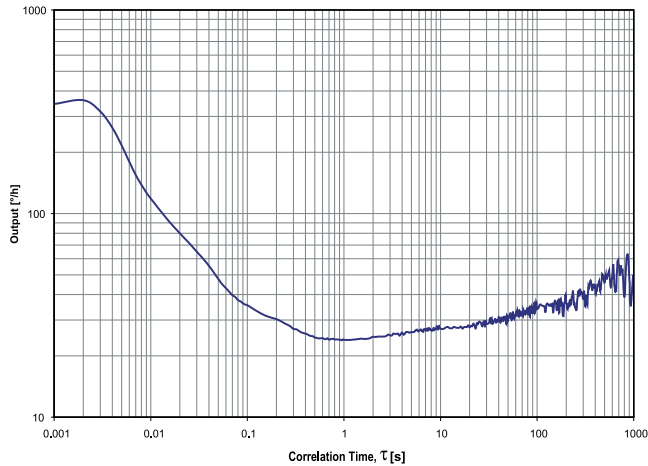

Figure 5.44 Switch-On Repeatability of Normalized Mean Bias

Allan Variance



**Figure 5.45 Allan Variance Plot
(75°/s setting)**

6 Glossary of Terms

ADC	Analogue to Digital Converter
ARW	Angular Random Walk
ASIC	Application Specific Integrated Circuit
BIT	Built-In Test
BW	Bandwidth
CBIT	Commanded Built-In Test
DAC	Digital to Analogue Converter
DRIE	Deep Reactive Ion Etch
DSBSC	Double Side-Band Suppressed Carrier Signal
EMC	Electro-Magnetic Compatibility
ESD	Electro-Static Damage
HBM	Human Body Model
IPC	Institute of Printed Circuits
LCC	Leadless Chip Carrier
LSB	Least Significant Bit
MEMS	Micro-Electro Mechanical Systems
NEC	Not Electrically Connected
PCBA	Printed Circuit Board Assembly
PPO	Primary Pick-Off
SF	Scale Factor
SMT	Surface Mount Technology
SPI [®]	Serial Peripheral Interface A registered trademark of Motorola, Inc.
SPO	Secondary Pick-Off

7 Interface

Physical and electrical inter-connect information for analogue and digital output modes, and digital SPI[®] message information for the digital output mode.

Physical Interface, Pad Layout and Pinouts:

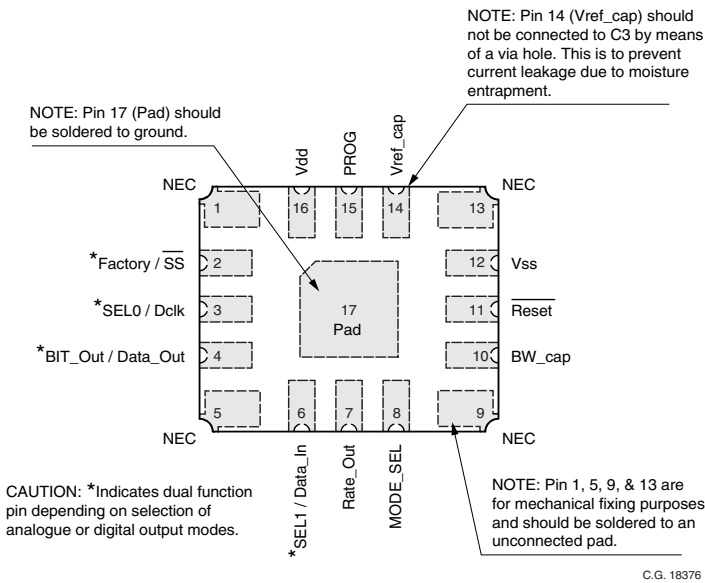

Figure 7.1 Pinout (CRM100) (Top View)

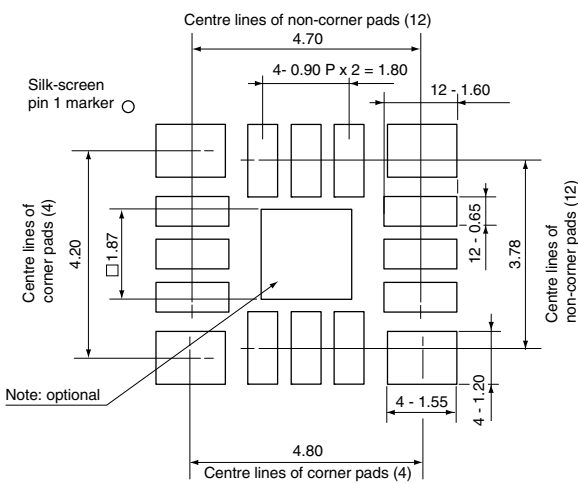

Figure 7.2 Recommended Pad Layout (CRM100)

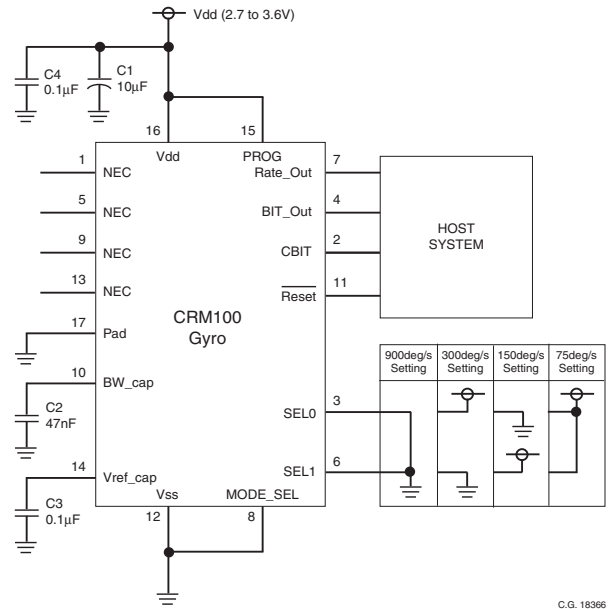

Figure 7.3 Peripheral Circuit - Analogue Output (CRM100)

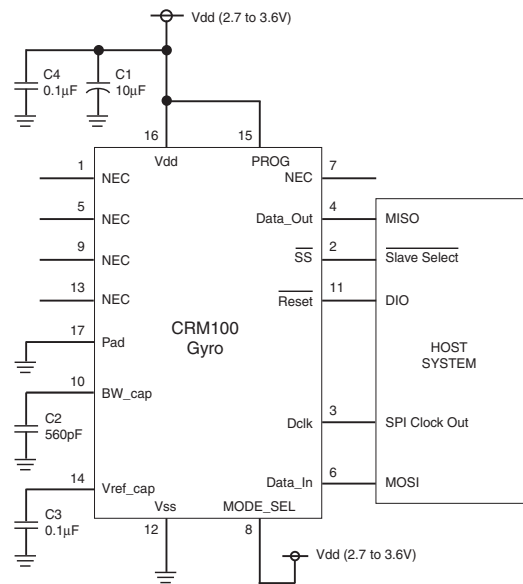

Figure 7.4 Peripheral Circuit - Digital Output (CRM100)

7.2 Input/Output Pin Definitions

The pin names, types, direction, levels and functions for the gyro are identified in Table 7.1 below

Pin Name		Pin Number	Pin Type	Pin Direction	Pin Levels	Pin Function	
Analogue Output Mode	Digital Output Mode					Analogue Output Mode	Digital Output Mode
CBIT	\overline{SS}	2	Digital	Input	CMOS with Pull-up of 110k Ω	In analogue mode this pin is used to initiate a commanded BIT function. Logic '0' = CBIT Enabled Logic '1' = CBIT Disabled	In digital mode this pin is the SPI [®] Select line.
SEL0	Dclk	3	Digital	Input	CMOS with Pull-up of 110k Ω	In analogue mode this pin provides one of the two rate range selection inputs.	In digital mode this pin is the SPI [®] Clock Output line from the Host System.
BIT_Out	Data_Out	4	Digital	Output	CMOS (secure/sink capability = 2mA)	In analogue mode this pin outputs the result of internal BIT, where a logical 'lo' state indicates a gyro failure.	In digital mode this pin is the SPI [®] Data Output line from the PinPoint [®] gyro.
SEL1	Data_In	6	Digital	Input	CMOS with Pull-up of 110k Ω	In analogue mode this provides one of the two rate range selection inputs.	In digital mode this is the SPI [®] Data Input line from the Host System.
Rate_Out	NEC	7	Analogue	Output	2 Ω output impedance	Analogue rate output from the PinPoint [®] gyro.	Not Electrically Connected.
MODE_SEL		8	Digital	Input	CMOS with Pull-down of 110k Ω	Used to select between analogue and digital modes of operation. If tied or pulled to Vss, analogue mode is selected. If tied or pulled to Vdd, digital mode is selected.	
BW_cap		10	Analogue	Output	50k Ω impedance	Used to select the gyro bandwidth. Minimum value of 560pF.	
\overline{RESET}		11	Digital	Input	CMOS with Pull-up of 110k Ω	Used to reset the gyroscope. This will reload the internal calibration data and will latch the SEL0 and SEL1 states to select a rate range.	Used to reset the gyroscope. This will reload the internal calibration data and the rate range will be initially set by the internal calibration constants.
Vss		12	Supply	n/a	0V (absolute max -0.3V)	Return connection for applied power (0V)	
Vref_cap		14	Analogue	Input	50k Ω impedance	Used to decouple the internal voltage reference for the gyroscope via an external capacitor. A 100nF ceramic capacitor with X7R dielectric is sufficient decoupling.	
PROG		15	Analogue	Input	100k Ω impedance	Used in factory to program calibration constants. Data cannot be altered. Pin MUST be connected to Vdd for correct operation.	
Vdd		16	Supply	n/a	2.7V to 3.6V (absolute max 4.0V)	Positive power supply to the gyroscope. Range from +2.7V to +3.6V. Supply should be decoupled from Vss with a 100nF ceramic capacitor (C4) with X7R dielectric. A bulk storage capacitor of 10 μ F should be placed near to the gyroscope.	
NEC		1, 5, 9 & 13	-	-	-	Not Electrically Connected. These pins provide additional mechanical fixing to the Host System and should be soldered to an unconnected pad.	
Pad		17	-	-	-	The primary function of this pin is to provide optional additional mechanical fixing to the Host System. If used, it is recommended this pin be connected to ground.	

Table 7.1 Pin Functions

Note 1: Digital I/O absolute maximum rating of -0.5V to Vdd+0.5V

Note 2: Digital input CMOS levels, low of 0.3xVdd and high of 0.7xVdd

Note 3: Digital output CMOS levels, low of 0.4V max and high of 0.8xVdd min

Note 4: Analogue I/O absolute maximum rating of -0.3V to Vdd+0.3V

7.3 Supply Voltage

The required supply voltage is 2.7 to 3.6V, and the ramp rate during power up should be > 1V/ms.

7.4 Measurement Range Set-Up

Dynamic range for the analogue output mode can be set at ±75°/s, ±150°/s, ±300°/s or ±900°/s [saturates at approximately ±1,000deg/s].

The dynamic range of the analogue output from the gyroscope is user selectable by means of two range select pins. This is described in Figure 7.3 (Peripheral Circuit Analogue Output). Note that the status of these range select pins is read at power-up and no attempt should be made to alter the rate range dynamically during operation.

Note; the analogue output remains available on pin 7 when the gyro is connected in Digital Output mode, however it is recommended that this is not used by the Host System and instead is non-electrically connected (NEC).

7.5 Bandwidth (Analogue Output)

The value of capacitor C2 (47nF) in the Peripheral Circuit shown in Figure 7.3 sets the bandwidth at 60Hz. To set other bandwidths select the C2 capacitor values according to the Table 7.2 below:

Capacitive Value of C2	Bandwidth (reference)
33nF	Typ 95Hz
47nF	Typ 70Hz
68nF	Typ 50Hz
100nF	Typ 33Hz
120nF	Typ 27Hz
270nF	Typ 12Hz

Table 7.2 Bandwidth Capacitor Values

The minimum value of C2 is 560pF. C2 should have a ceramic dielectric.

For angular rate inputs in the frequency range DC to 120Hz, the analogue response of PinPoint® can be approximated by the following expression:

$$V_o = \frac{V_{dd}}{2} + \left(\frac{k d\theta / dt}{1 + (2\pi f R C_{BW})} \right)$$

Note: $C_{BW} = C2$

Where:

V_{dd} is the supply voltage,
dθ/dt is the rate of rotation about the sense axis,
k is the scale factor coefficient dependent on rate range and supply voltage. Note that the sensor is ratiometric with respect to the supply voltage when operating in analogue output mode:

For ±75°/s operation, $k = 0.012 \times V_{dd}/3$

For ±150°/s operation, $k = 0.006 \times V_{dd}/3$

For ±300°/s operation, $k = 0.003 \times V_{dd}/3$

For ±900°/s operation, $k = 0.001 \times V_{dd}/3$

f is the frequency of the rate of rotation (if not steady state),
R is the roll-off resistor inside the ASIC (nominally 48kΩ),
C_{BW} is the bandwidth capacitor (C2).

Note that wide band frequency response approximates to a third order. A more thorough expression of bandwidth is.

$$\omega_{C2} = \frac{\omega}{\left[\frac{1}{0.5 \left(1 + \left(\frac{\omega}{1760} \right)^3 \right)} \right]^{-1}}$$

where $\omega_{C2} = \frac{1}{RC_2}$

R is nominally 48kΩ but has a process tolerance of ±14%.

7.6 Bandwidth (Digital Output)

The Bandwidth on the Digital Output follows that of the Analogue mode, being set by C2 as described in section 7.5. However, to optimise the oversampling performance of the ADC, the user may make this value 560pF and implement digital filter algorithms in the Host system.

7.7 Non-Electrical Connections (NEC)

Pins 1, 5, 9 and 13 are **NOT** to be connected electrically, they are for mechanical purposes only. Also pin 7 is **NOT** to be connected electrically when the gyro is in Digital Output mode.

7.8 Built In Test (BIT) & Commanded Built In Test (CBIT)

PinPoint® contains a sophisticated health monitoring system that continuously checks a number of key parameters within the gyro control ASIC. For ease of use, each of the parameters are verified against internal limits and the results gated together, such that the user gets a single BIT line confirming the correct operation of the gyro.

The functions that are monitored are as follows, with any failure resulting in BIT_Out being set to false (logic '0'):

1. The calibration data memory area is checked for parity at power-up. In the event that any single data bit has failed, BIT_Out will be set to false.
2. The trim and calibration coefficients in the data memory are fed into the control electronics by means of individual DAC conversion stages. These are also verified at power up, so that an incorrect conversion of trim data into performance setting will result in BIT_Out being set to false.
3. For correct operation, the MEMS silicon ring is set into oscillation at its resonant frequency to a preset amplitude. The primary drive control loops set the amplitude of motion of the ring using an Automatic Gain Control (AGC) circuit. The BIT system monitors the required drive from the AGC: if the required drive is too high, (indicating either an electronic drive failure, a transducer failure or a structural failure of the ring itself), the BIT_Out signal will be set false. Similarly, if the AGC level is too low, (indicating a failure in the control loop electronics or the drive transducer), BIT_Out will be set to false. One consequence of this function is that, during startup, the BIT_Out will be set false until the loops have closed and stabilised to the correct values.
4. The angular rate output is derived from the demodulated secondary pick-off signal. The amplitude of this signal is checked against a maximum: in the event that the gyro is rotated at an angular rate beyond the level at which the control loops can operate, (i.e. $\gg 1,000^\circ/\text{s}$), then the saturation of the demodulator will set BIT_Out to false. Note that BIT_Out will NOT be set to false when the Analogue Rate Output stage saturates: for example, if the gyro is configured for $75^\circ/\text{s}$ range, and rotated at $300^\circ/\text{s}$, the internal control electronics will still operate correctly and BIT_Out will **NOT** be set false.
5. Key to PinPoint®'s performance is the balance of the MEMS ring and matching of the secondary transducers. These aspects are internally monitored by measuring the demodulated quadrature signal from the rate demodulation stage. Whilst this signal contains no direct angular rate information, its magnitude is a very good indication regarding the health of the transducers, the ring and the demodulation electronics. Any excess quadrature signal will result in BIT_Out being set to false.

In addition, the SPI® message has a checksum calculation performed. Any checksum failure will be reported as a separate flag in the SPI® message - see Section 7.12.5.

A 'Commanded Built In Test' (CBIT) is also available which allows the user to request a test function to be applied, causing an offset to appear on the rate signal equivalent to 50% of rate. This test function can be initiated by the use of the CBIT input pin in analogue mode or via the SPI® interface in digital mode. When CBIT is enabled the BIT_Out signal is set to 'false' to indicate the device is in the test mode.

The function checks a large proportion of the gyro functionality including the primary loop, secondary pick-off amplifiers, secondary rate channel filtering, rate range selection, rate output buffer, ADC references, ADC conversion and digital output filtering.

7.9 Temperature Sensor

The ASIC within PinPoint® contains a temperature sensor cell that is accessible only via the digital interface. Users may interrogate this sensor as described in Section 7.12.5 such that the thermal characteristics of any individual PinPoint® gyro can be compensated at system level. Dependent on the level of compensation required, algorithms that use linear fits, quadratic fits or piece-wise-linear lookup tables will further enhance the system level performance. It is preferable in such applications to use the internal temperature sensor rather than an external temperature sensor so as to avoid the effects of system level thermal gradients.

For example, a second order polynomial correction for both offset and sensitivity could be described as.

$$\omega_r = (a + b\Delta T + c\Delta T^2) + \omega_{20^\circ C} (1 + d\Delta T + e\Delta T^2)$$

The sensitivity of the temperature sensor is nominally 2.75 LSB / °C, with +25°C being represented by $600_{10} \pm 20_{10}$ LSB.

The sensor is an integral part of the ASIC. The power consumption of PinPoint® is so low that the thermal asymmetry between the control electronics and the ring itself is extremely low.

The temperature signal is not available as an analogue signal.

7.10 Power Supply Noise Rejection

By design, PinPoint® is a ratiometric sensor; the analogue output characteristics are therefore controlled by both the applied angular rate and the supply voltage. Consequently the user should take any necessary precautions to manage the supplies from a noise and ripple viewpoint. Any noise or ripple within the selected pass band will appear on the output at half the magnitude. Good system decoupling is recommended for best performance. If ratiometric response is not desired, then PinPoint® should be operated either from a well regulated supply or alternately, the digital output should be used. By virtue of the internal ADC sharing a common reference voltage, the digital output is not ratiometric.

In addition, PinPoint® determines the angular rate from a double-sideband suppressed carrier signal superimposed on the primary resonance of the vibrating ring. The carrier is at a frequency of nominally 22kHz. In common with all demodulation systems, power supply rejection at the demodulation frequency and its odd harmonics is limited, and care should be taken to minimise power supply ripple at frequencies around 22kHz, 66kHz and 110kHz. If the system is to be supplied from a switching regulator, it is recommended that the switching frequency should be not less than 150kHz.

7.11 PROG pin 15 – Special Note

The factory calibration is effected by One Time Programmable setting via pin 15. Users should ensure that this is connected to Vdd. Voltages in excess of Vdd applied to this pin may permanently and irreversibly damage the calibration area of the device.

7.12 Digital Mode

To activate the digital mode of operation for the PinPoint® gyro, it is necessary to connect the MODE_SEL (Pin 8 on CRM100) input to the positive supply rail (Vdd). This not only activates the internal ADC, but also switches a number of the I/O pins to secondary functions to create the interface. The recommended configuration is shown in Figure 7.4 Peripheral Circuit (Digital Mode).

7.12.1 Digital SPI® Interface

The digital interface is configured as SPI® operating as a 'Slave' in a 'Mode 0' configuration. [Note: for interfacing to most microcontrollers, this is often set up as CPOL=0 and CPHA=0].

Figure 7.5 shows the principle of SPI® data transfer. Data is transferred to the Host System and PinPoint® in complete messages which are 6 bytes or 48 bits in length.

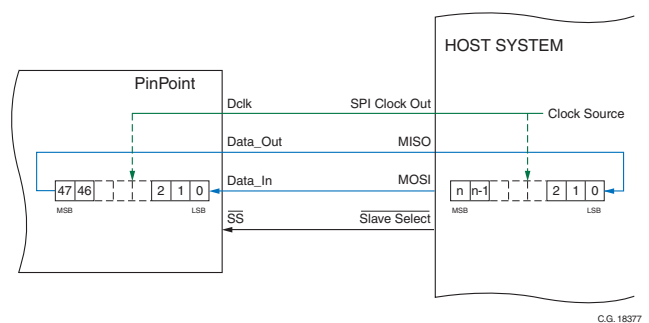

Figure 7.5 SPI® Data Transfer Principle

As shown in Figure 7.5, the Host System acts as a SPI master and provides the clock to the SPI® shift registers. In most instances the Host System cannot take all 48 bits in one tranche as the receive registers are 8 or 16-bit wide. Because the Host System is running as a SPI® master, it is relatively simple to take the data one byte or word at a time as a single bit is shifted on each clock cycle.

For example, if the Host System needs to read the data on a byte-by-byte basis, the steps required are:

1. Set \overline{SS} to a logic 0 to initiate the transfer.
2. Send 8 SPI® clock cycles to transfer a byte of data between PinPoint® and the Host System.
3. The Host System can store the received byte.
4. Repeat 2 and 3 until all 6 bytes have been received.
5. Set \overline{SS} to a logic 1 to complete the transfer.

A full timing diagram is shown in Figure 7.6 with the parameters detailed in Table 7.3.

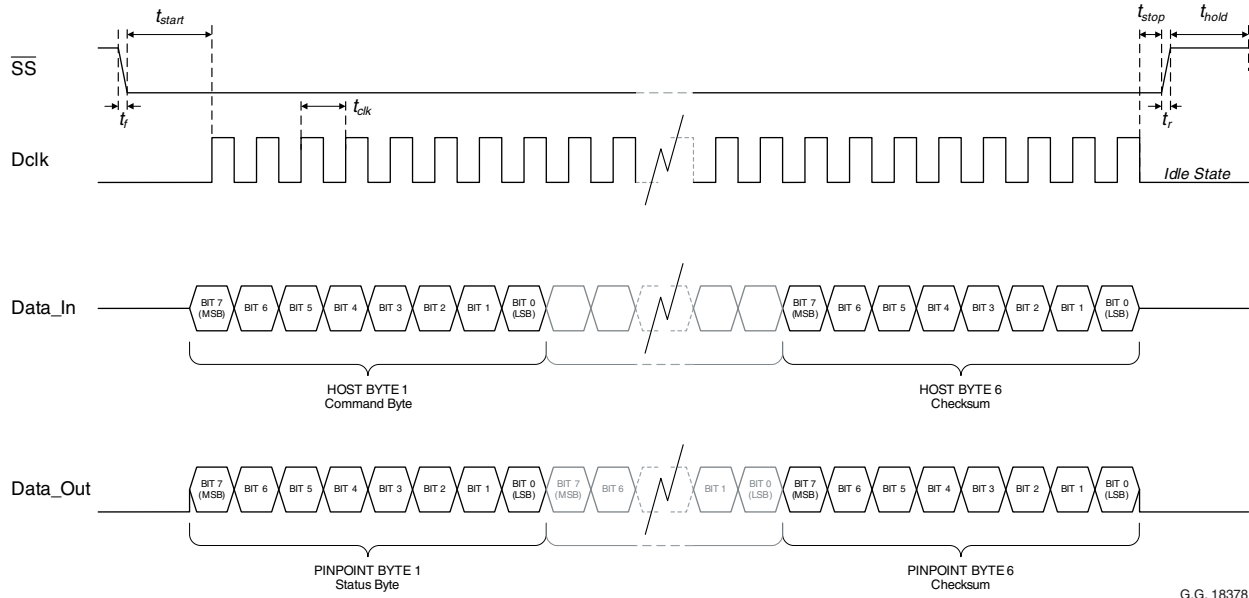

G.G. 18378

Figure 7.6 SPI[®] Timing

Parameter	Min	Typical	Max
t_{start}	25 μ s	-	-
t_{stop}	5 μ s	-	-
t_{hold}	15 μ s	-	-
t_f	-	20ns	-
t_r	-	20ns	-
t_{clk}	10 μ s	1 μ s	0.125 μ s

Table 7.3 SPI[®] Timing Parameters

7.12.2 SPI[®] Bus Limitation (Early Samples)

Early samples of PinPoint[®] are identified by the 14 character lot identifier beginning with '1'. These parts had a known tri-state limitation. The gyro implementation did not appear as a high impedance load when deselected ($SS = 1$) and as a result the $Data_Out$ pin (Pin 4 on CRM100) would still be active. Therefore it is recommended that PinPoint[®] gyros having the designation 1xxxx are the only device connected to the Host System on a dedicated gyro SPI[®] bus.

This has been corrected by a Silicon change which is identified by the lot identifier beginning with '3'.

7.12.3 Message Structure

As previously described, 6 bytes of data are transferred to and from the PinPoint[®] gyro for each message. Individually, the messages are made up of bytes as follows:

Data from the Host System is known as a Command Message and is configured as shown in Figure 7.7.

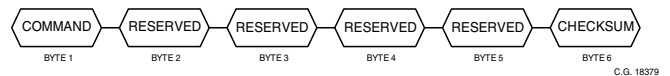

Figure 7.7 Command Message Structure

Data from the PinPoint[®] gyro is known as a Status Message and is configured as shown in Figure 7.8.

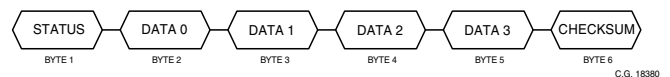

Figure 7.8 Status Message Structure

7.12.4 Command Message

Command Byte (Byte 1)

The 8 bit Command byte sent from the Host System has the format specified in Figure 7.9.

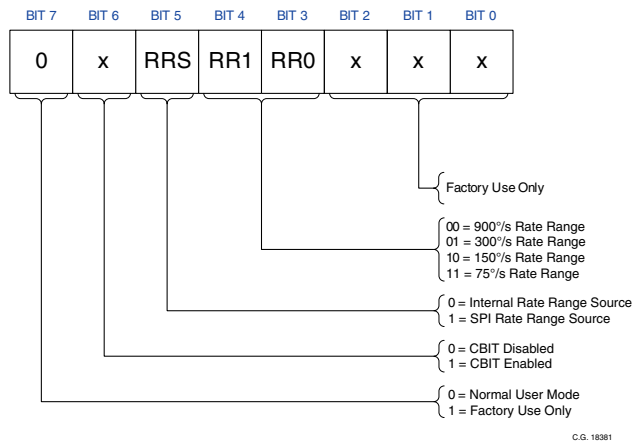

Figure 7.9 Command Byte Format

Bit 7 '0' = Normal User Mode
 '1' = Factory Use Only

Bit 7 MUST be set to '0' for the Host System to receive useful data from the PinPoint® gyro. The data returned contains both rate and temperature information.

Bit 6 '0' = CBIT Disabled
 '1' = CBIT Enabled

Bit 6 is used to enable the 'Commanded Built In Test' function (BIT) which produces a 50°/s nominal offset on the rate output signal.

Bit 5 '0' = Internal Rate Range
 '1' = SPI® Rate Range

Bit 5 identifies the source for setting the Rate Range. If the bit is set to a '0', then the source becomes the internal factory default ($\pm 75^\circ/\text{s}$). If the bit is set to a '1', then bits 4 and 3 in the message are used to make the required Rate Range selection.

Bits 4 & 3 '00' = $\pm 900^\circ/\text{s}$ Rate Range
 '01' = $\pm 300^\circ/\text{s}$ Rate Range
 '10' = $\pm 150^\circ/\text{s}$ Rate Range
 '11' = $\pm 75^\circ/\text{s}$ Rate Range

Bits 4 and 3 are used in combination to select the Rate Range via the SPI® bus.

Bits 2, 1 & 0 Factory Use Only

Reserved Bytes (Bytes 2 to 5)

Reserved for Factory Use Only. The content of each byte is ignored by the PinPoint® gyro.

Checksum Byte (Byte 6)

The Checksum Byte is used by the PinPoint® gyro to ensure that the message is valid. This is a computed binary number which is the least significant 8 bits of the logical inverse of the sum of bytes 1 to 5 inclusive. As an example, here is a command to request data from a $\pm 150^\circ/\text{s}$ rate range gyro:

```

Command Byte 0x30
Reserved      0x00
Reserved      0x00
Reserved      0x00
Reserved      0x00
    
```

The sum of these bytes is 0x30 and its logical inverse is 0xCF. Thus the checksum byte is:

```
Checksum      0xCF
```

The complete message transmitted, in **hexadecimal** format, would therefore be:

```
3000000000CF
```

7.12.5 Status Message

Status Byte (Byte 1)

The 8 bit status byte sent from the PinPoint® gyro has the format specified in Figure 7.10.

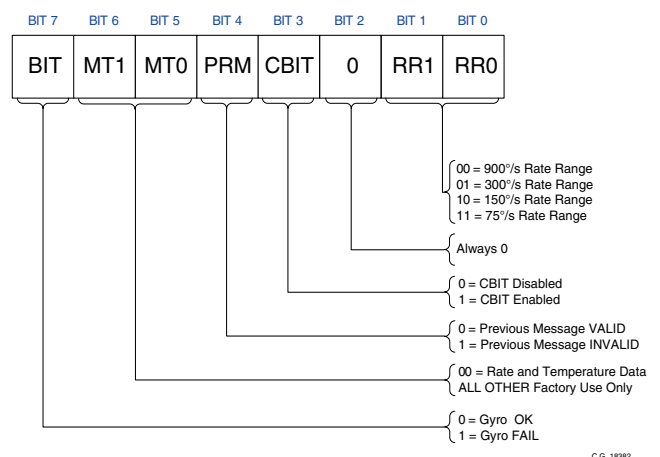

Figure 7.10 Status Byte Format

Bit 7 '1' = Gyro Fail
 '0' = Gyro OK

Bit 7 identifies the working state of the PinPoint® gyro. If this bit is set to a '1', then the PinPoint® gyro has failed its internal checks and the data within the message contained in bytes 2 to 5 should be considered invalid, and if set to a '0' then the PinPoint® gyro has successfully passed its internal checks and the data within the message contained in bytes 2 to 5 can be considered valid. Bit 7 is also set to a '1' if CBIT function is enabled.

Bits 6 & 5 '00' = Rate/Temp Data

Bits 6 and 5 return an identifier to the message type, and therefore identify the data types within bytes 2 to 5. Message Type '00' is the only one available to the Host System as all others are for Factory Use Only.

Bit 4 '1' = Previous Message Invalid
 '0' = Previous Message Valid

Bit 4 provides feedback with regard to the previous Command Message sent by the Host System. If the bit is set to a '1' then the last message received was corrupt (i.e. the checksum was invalid) and the message was ignored. The output message type will be that selected in the last valid Command Message.

Bit 3 '1' = CBIT Enabled
 '0' = CBIT Disabled

Bit 3 indicates if the Commanded Built In Test (CBIT) function is enabled or disabled.

Bit 2 '00' = Normal

Bit 2 should always return '00'.

Bits 1 & 0 '00' = ±900°/s Rate Range
 '01' = ±300°/s Rate Range
 '10' = ±150°/s Rate Range
 '11' = ±75°/s Rate Range

Data Byte - Rate (Byte 2 and 3)

Data bytes 2 and 3 contain the Rate Data information from the PinPoint® gyro. Byte 2 is the MS byte and byte 3 is the LS byte of the complete word. The data is represented in 2's complement format.

The scale factor of the data word is dependent upon the rate range selected in the Command Message. Table 7.4 shows the relationship.

Rate Range (°/s)	Scale Factor (bits/(°/s))
±75	96
±150	48
±300	24
±900	8

Table 7.4 Digital Rate Scale Factors

For example; a rate word value of 12C0 (hex) would be equal to +50°/s on the ±75°/s rate range, or a value of F4C0 (hex) would be equal to -120°/s on the ±300°/s rate range.

Data Byte - Temp (Byte 4 and 5)

Data bytes 4 and 5 contain the internal Temperature Data information from the PinPoint® gyro. Byte 4 is the MS byte and byte 5 is the LS byte of the complete word. The data is represented in unsigned binary format.

A temperature code of 0200 (hex), equivalent to 512 in decimal, represents 0°C. The scale factor of the data word is fixed at 2.75 bits/°C.

For example; -40°C would be represented by 0192 (hex) or 402 (dec) and +85°C as 02E9 (hex) or 745 (dec).

Checksum Byte (Byte 6)

The Checksum Byte is used by the PinPoint® gyro to ensure that the message is valid.

7.12.6 Digital Bandwidth













The bandwidth for the PinPoint® gyro in digital output mode is determined by the value of capacitor C2. However, to optimise the oversampling performance of the ADC, the user may make this value 560pF and implement digital filter algorithms in the Host System.

7.12.7 SPI® Sampling Rate and Clock Frequency



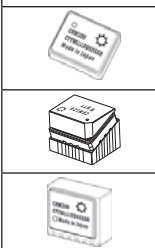

It is recommended that the Host System takes data from the gyroscope at a rate of 1,000 messages per second (1kHz). Message rates up to 10kHz may be accommodated, but rates less than 500Hz may lead to unwanted aliasing in the frequency domain.

The recommended SPI® clock frequency is 1MHz (100kHz minimum to 8MHz maximum).

8 Design Tools and Resources Available

Item	Description of Resource	Part Number	Order/Download
	PinPoint® Brochure: A one page sales brochure describing the key features of the PinPoint® gyro.	CRM100-00-0100-131	Download (www.pinpoint-gyro.com)
	PinPoint® CRM100 Datasheet: Full technical information on all PinPoint® gyro part number options. Specification and other essential information for assembling and interfacing to PinPoint® gyros, and getting the most out of them.	CRM100-00-0100-132	Download (www.pinpoint-gyro.com)
	PinPoint® CRM120 Datasheet: Full technical information on all PinPoint® gyro part number options. Specification and other essential information for assembling and interfacing to PinPoint® gyros, and getting the most out of them.	CRM120-00-0100-132	Download (www.pinpoint-gyro.com)
	PinPoint® CRM200 Datasheet: Full technical information on all PinPoint® gyro part number options. Specification and other essential information for assembling and interfacing to PinPoint® gyros, and getting the most out of them.	CRM200-00-0100-132	Download (www.pinpoint-gyro.com)
	PinPoint® Presentation: A useful presentation describing the features, construction, principles of operation and applications for the PinPoint® gyro.	—	Download (www.pinpoint-gyro.com)
	Single-axis PinPoint® gyro evaluation boards (CRM100 & CRM200 options): Single PinPoint® gyro fitted to a small PCBA for easy customer evaluation and test purposes. Analogue output only. SMT solder pads provided for wire links to the customer host system. Measurement range and bandwidth are customer-selectable by on-board cut-able links (default $\pm 75^\circ/\text{s}$) and by soldering the appropriate 0805 footprint SMT capacitor value (capacitors not supplied). Designed to be fixed to the host using epoxy or double-sided tape.	400046-0100 (CRM100)	Order
		400046-0200 (CRM200)	Order
	Three-axis PinPoint® gyro evaluation board (CRM100 & 2x CRM200): Three PinPoint® gyros fitted to a small PCBA for easy customer evaluation and test purposes. Analogue and digital outputs. SMT solder pads provided for wire links to the customer host system. Digital interface has three separate SPI® lines. Measurement range and bandwidth are customer-selectable by on-board cut-able links (default $\pm 75^\circ/\text{s}$) and by soldering the appropriate 0805 footprint SMT capacitor value (capacitors not supplied). Designed to be fixed to the host by either using epoxy, double-sided tape or using the four screws supplied.	400046-0300	Order
	Solid Model CAD files for PinPoint® gyros: Available in .STP and .IGS file format	CRM100-00-0100-408	Download (www.pinpoint-gyro.com)
		CRM120-00-0100-408	
		CRM200-00-0100-408	
	Library Parts: Useful library component files of PinPoint® gyros: DxDesigner Schematic Symbols. PADS Decal (Footprint) PADS Part Type File.	—	Download (www.pinpoint-gyro.com)

Design Tools and Resources Available Continued

Item	Description of Resource	Part Number	Order/Download
	Reference Circuit: A useful reference circuit design gerber files for the PinPoint® gyro for use in host systems with either analogue or digital output modes.	—	Download (www.pinpoint-gyro.com)
	Interface: Off-the-peg sudo code and a simple flowchart with message handling instructions for use as a customer aid to developing their own interface directly to a PinPoint® gyro via the SPI®.	—	Download (www.pinpoint-gyro.com)
	Questions and Answers: Some useful questions asked by customers and how we've answered them. This is an informal (uncontrolled) document intended purely as additional information.	—	Download (www.pinpoint-gyro.com)
	RoHS compliance statement for PinPoint®: PinPoint® is fully compliant with RoHS. For details of the materials used in the manufacture please refer to the MDS Report.	—	Download (www.pinpoint-gyro.com)
	MDS Reports for PinPoint®: Material declaration required for automotive applications.	—	Download (www.pinpoint-gyro.com)

9 Cleaning

Due to the natural resonant frequency and amplification factor ('Q') of the sensor, ultrasonic cleaning should NOT be used to clean the PinPoint® gyro.

10 Soldering Information

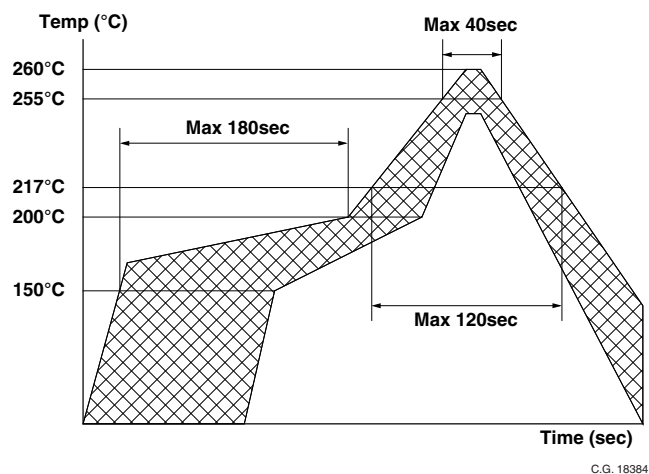

Figure 10.1 Recommended Reflow Solder Profile

11 Part Number Markings

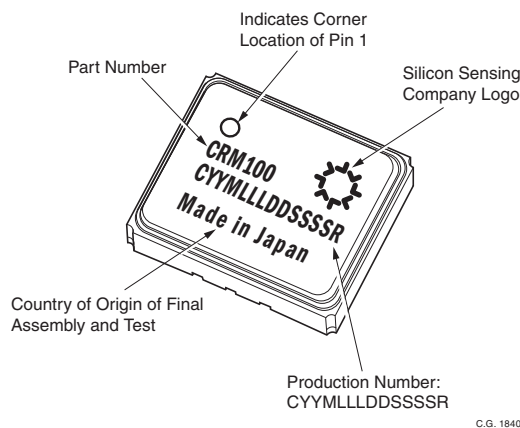

Figure 11.1 Part Marking

	Code	Range
Configuration	C	0 - 9
Year Number	YY	00 - 99
Month Number	M	1 - 9, X, Y, Z
Batch Lot Number	LLL	001 -999
Lot Split	DD	00 - 99
Serial Number	SSSS	0001 - 9999
Measurement Times	R	0 - 9

Table 11.1 Production Number Code

12 Packaging Information

Layer	Type	Quantity
CRM100	Tape and Reel	Max. 2000 pcs/ 1 Reel
Inner Bag	Aluminium Damp-proof Bag	1 Reel/Bag
Inner Box	Cardboard Box	Inner Bag x 1/Inner Box
Outer Box	Cardboard Box	Inner Box/Outer Box

Table 12.1 Packaging Information

Item	Dimension	Quantity	Material
Reel	DR2 23316C	1 Reel	PS
Emboss Tape	TE1612-091009-2	1 Roll	PS
Cover Tape	ALS-ATA 13.5mm x 480m	1 Roll	PET, PE, PS
Label for Reel	40mm x 80mm	1 label/Reel	Paper
Desiccant	FA 10g	1 Inner Bag	-
Inner Bag	0.101mm x 450mm x 530mm	1 Reel/Inner Bag	MB4800
Tray	451mm x 429mm x 55mm	2 Tray/Outer Box	-
Pad	451mm x 429mm x 20mm	3 Pad/Outer Box	-
Inner Box	413mm x 391mm x 52mm	2 Inner Box/ Outer Box	Cardboard
Outer Box	462mm x 440mm x 208mm	1 Box	Cardboard
Label for Outer Box	102mm x 127mm	1 label/Outer Box	Paper

Table 12.2 Packaging Specification

Reel Information

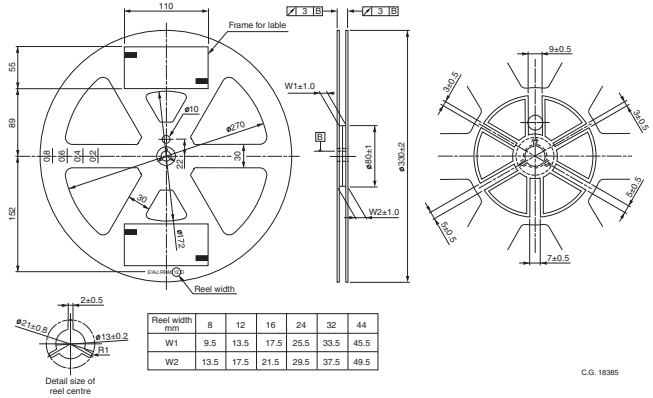

C.G. 18385

Emboss Tape Carrier Information

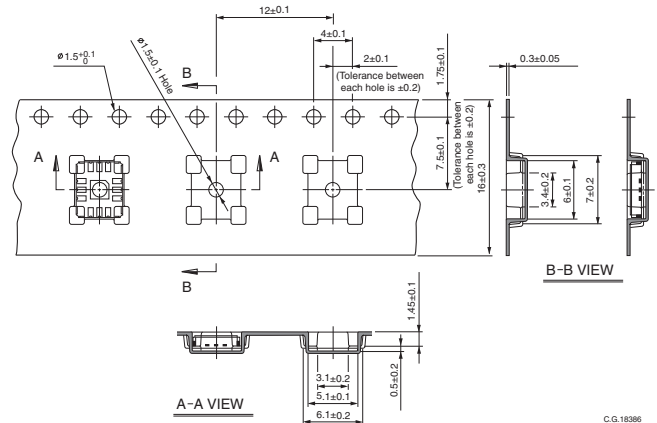

C.G. 18386

Tape Information

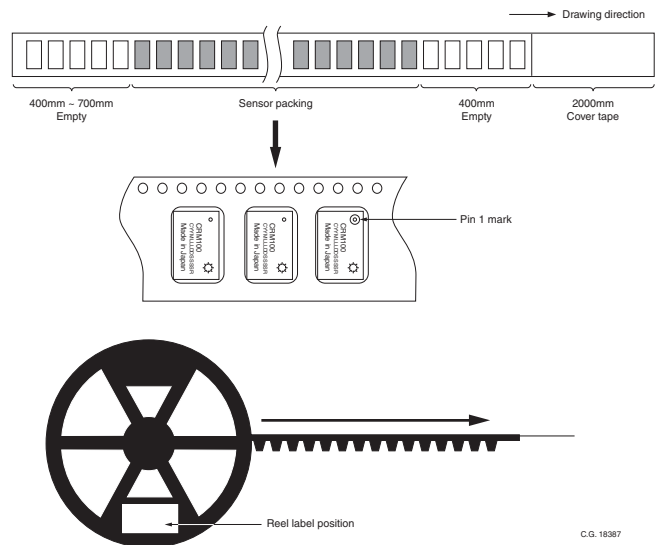

C.G. 18387

Label for Reel Information

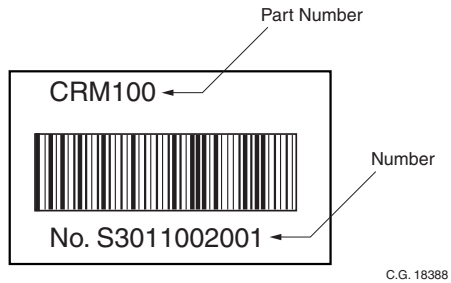

Outer Box Packing Information

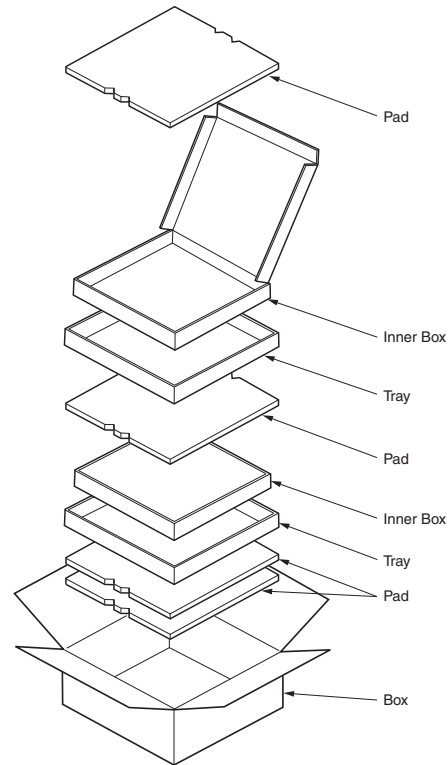

Inner Bag Packing Information

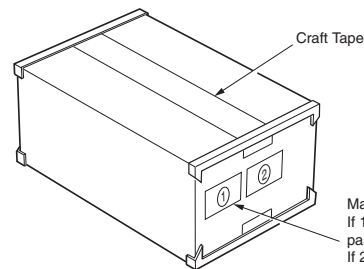
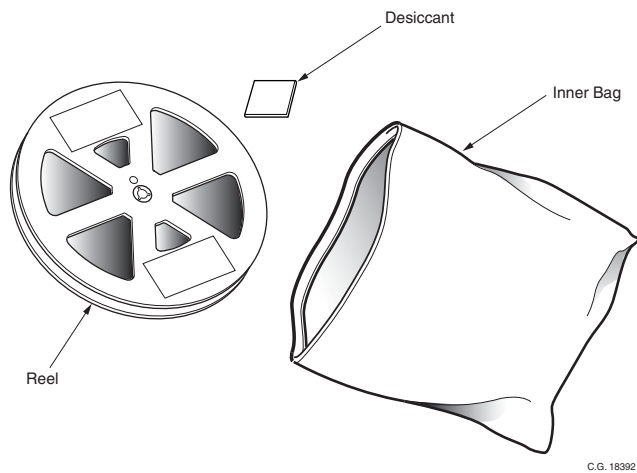

Maximum of two Reels per Outer Box.
 If 1 Reel is contained in Outer Box, label is pasted in position 1.
 If 2 Reels are contained in Outer Box, labels are pasted in positions 1 and 2.
 Each label shows packaged reel information.

C.G. 18390

Inner Box Packing Information

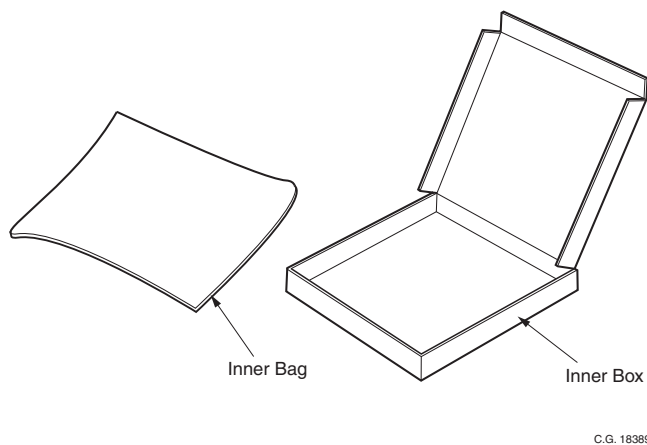

13 Internal Construction and Theory of Operation

Construction

PinPoint® is available in two basic configurations, one which will measure angular velocity about an axis perpendicular to the plane of the host PCBA ('in-plane' sensing - CRM100) and one which measures angular velocity about an axis which is parallel to the plane of the host PCBA ('orthogonal' sensing - CRM200).

PinPoint® (CRM100 and CRM200) is supplied as a PCBA surface mountable LCC ceramic packaged device. It comprises five main components; silicon MEMS ring Sensor, Silicon Pedestal, ASIC and the Package Base and Lid. The MEMS ring Sensor, ASIC and Pedestal are housed in a hermetically sealed package cavity with a nitrogen back-filled partial vacuum, this has particular advantages over sensors supplied in plastic packages which have Moisture Sensitivity Level limitations.

A schematic drawing of CRM100 showing the main components is given in Figure 13.1 below. The principles of construction for CRM200 are the same as CRM100.

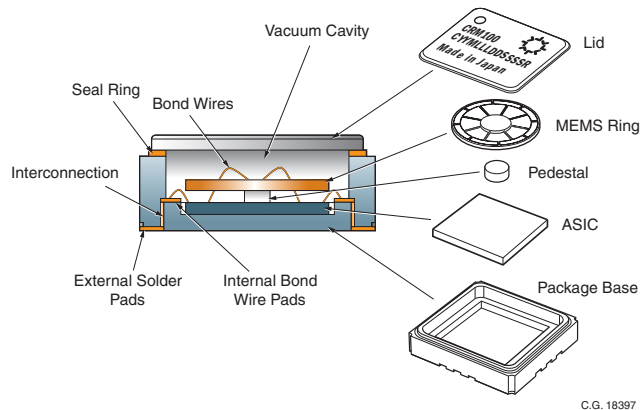

Figure 13.1 CRM100 Main Components

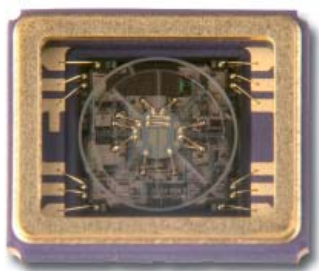

Figure 13.2 CRM100 (Lid Removed)

Silicon MEMS Ring Sensor

The 3mm diameter by 65µm thick silicon MEMS ring is fabricated by Silicon Sensing using a DRIE (Deep Reactive Ion Etch) bulk silicon process on a 5 inch wafer. The annular ring is supported in free-space by eight pairs of 'dog-leg' shaped symmetrical spokes which radiate from a central 1mm diameter solid hub.

The bulk silicon etch process and unique patented ring design enable close tolerance geometrical properties for precise balance and thermal stability and, unlike other MEMS gyros, there are no small gaps to create problems of interference and stiction. These features contribute significantly to PinPoint®'s bias and scale factor stability over temperature, and vibration and shock immunity. Another advantage of the design is its inherent immunity to acceleration induced rate error, or 'g-sensitivity'.

Strain film actuators/transducers are attached to the upper surface of the silicon ring perimeter and are electrically connected to bond pads on the ring hub via tracks on the spokes. These actuate or 'drive' the ring into its Cos2θ mode of vibration at a frequency of 22kHz or detect radial motion of the ring perimeter either caused by the primary drive actuator or by the coriolis force effect when the gyro is rotating about its sensing axis. There is a single pair of primary drive actuators and a single pair of primary pick-off transducers, and two pairs of secondary pick-off transducers.

The combination of transducer technology and eight secondary pick-off transducers improves PinPoint®'s signal-to-noise ratio, the benefit of which is a very low-noise device with excellent angular random walk properties which are key to inertial navigation type applications, as well as camera/antenna pointing stability.

Pedestal

The hub of the MEMS ring is supported above the ASIC on a 1mm diameter cylindrical silicon pedestal, which is bonded to the ring and ASIC using an epoxy resin.

ASIC

The ASIC is a 3mm x 3mm device fabricated using 0.35µm CMOS process. ASIC and MEMS are physically separate and are connected electrically by using gold bond wires and thus the ASIC has

no MEMS-to-ASIC internal tracking, meaning there is reduced noise pick-up and excellent EMC performance. Gold bond wires also connect the ASIC to the internal bond pads on the Package Base.

Package Base and Lid

The LCC ceramic Package Base is a multi-layer aluminium oxide construction with internal bond wire pads connected through the Package Base via integral multi-level tungsten interconnects to a series of external solder pads. Similar integral interconnects in the ceramic layers connect the Lid to Vss, thus the sensitive elements are inside a Faraday shield for excellent EMC. Internal and external pads are electroplated gold on electroplated nickel.

The Package Base incorporates a seal ring on the upper layer onto which a Kovar® metal Lid is seam welded using a rolling resistance electrode, thus creating a totally hermetic seal. Unlike other MEMS gyro packages available on the market, PinPoint® has a specially developed seam weld process which eliminates the potential for internal weld spatter. Inferior designs can cause dislodged weld spatter which affects gyro reliability due to interference with the vibratory MEMS element, especially where the MEMS structure has small gaps, unlike PinPoint® with its large gaps as described above.

Theory of Operation

Pinpoint® is a solid-state device and thus has no moving parts other than the deflection of the ring itself. It detects the magnitude and direction of angular velocity by using the 'coriolis force' effect. As the gyro is rotated coriolis forces acting on the silicon ring cause radial movement at the ring perimeter.

There are eight actuators/transducers distributed evenly around the perimeter of the silicon MEMS ring. Located about its primary axes (0° and 90°) are a single pair of 'primary drive' actuators and a single pair of 'primary pick-off' transducers. Located about its secondary axes (45° and 135°) are two pairs of 'secondary pick-off' transducers.

The 'primary drive' actuators and 'primary pick-off' transducers act together in a closed-loop system to excite and control the ring primary operating vibration amplitude and frequency (22kHz).

Secondary 'pick-off' transducers detect radial movement at the secondary axes, the magnitude of which is proportional to the angular speed of rotation and from which the gyro derives angular rate. The transducers produce a double sideband, suppressed carrier signal, which is demodulated back to a baseband, the width of which is controlled by the user by one simple external capacitor. This gives the user complete flexibility over in system performance, and makes the transduction completely independent of DC or low frequency parametric conditions of the electronics.

Referring to Figures 13.3(a) to 13.3(d)

Figure 13.3(a) shows the structure of the silicon MEMS ring. Figure 13.3(b) shows the ring diagrammatically, the spokes, actuators and transducers removed for clarity, indicating the Primary Drive actuators (single pair), Primary Pick-Off transducers (single pair) and Secondary Pick-Off transducers (two pairs). In Figure 13.3(b) the annular ring is circular and is representative of the gyro when unpowered.

When powered-up the ring is excited along its primary axes using the Primary Drive actuators and Primary Pick-Off transducers acting in a closed-loop control system within the ASIC. The circular ring is deformed into a 'Cos2θ' mode which is elliptical in form and has a natural frequency of 22kHz. This is depicted in Figure 13.3(c). In Figure 13.3(c) the gyro is powered-up but still not rotating. At the four Secondary Pick-Off nodes located at 45° to the primary axes on the ring perimeter there is effectively no radial motion.

If the gyro is now subjected to applied angular rate, as indicated in Figure 13.3(d), then this causes the ring to be subjected to coriolis forces acting at a tangent to the ring perimeter on the primary axes. These forces in turn deform the ring causing radial motion at the Secondary Pick-Off transducers. It is the motion detected at the Secondary Pick-off transducers which is proportional to the applied angular rate.

The DSBSC signal is demodulated with respect to the primary motion, which results in a low frequency component which is proportional to angular rate.

All of the gyro control circuitry is hosted in the ASIC. A block diagram of the ASIC functions is given in Figure 1.1 in Section 1.

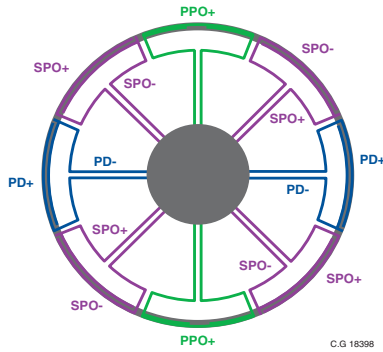

Figure 13.3(a)

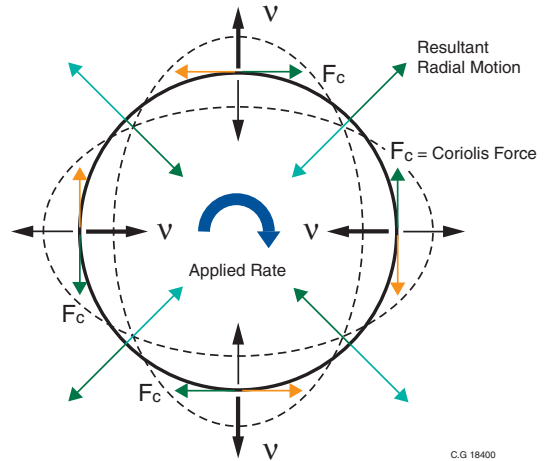

Figure 13.3(d)

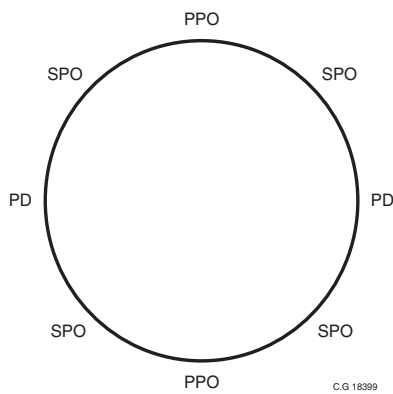

Figure 13.3(b)

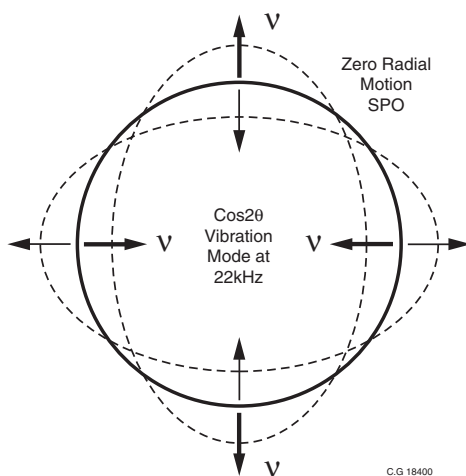

Figure 13.3(c)

14 Patent Applications

The following patent applications have been filed for the PinPoint® gyro sensors:

Patent Application	Status
US5226321	Granted
US5419194	Granted
US6698271	Granted
WO2009/119205	Patent Pending

Notes

Silicon Sensing Systems Limited
Clifford Road Southway
Plymouth Devon
PL6 6DE United Kingdom
T: +44 (0)1752 723330
F: +44 (0)1752 723331
W: pinpoint-gyro.com

Silicon Sensing Systems Japan Limited
1-10 Fuso-Cho
Amagasaki
Hyogo 6600891 Japan
T: +81 (0)6 6489 5868
F: +81 (0)6 6489 5919
W: pinpoint-gyro.com

Specification subject to change without notice.

© Copyright 2011
Silicon Sensing Systems Limited
All rights reserved.

Printed in England 04/2011
Date 27/04/2011

CRM100-00-0100-132 Rev 6
DCR No. 620002648